

# Charlotte's Web

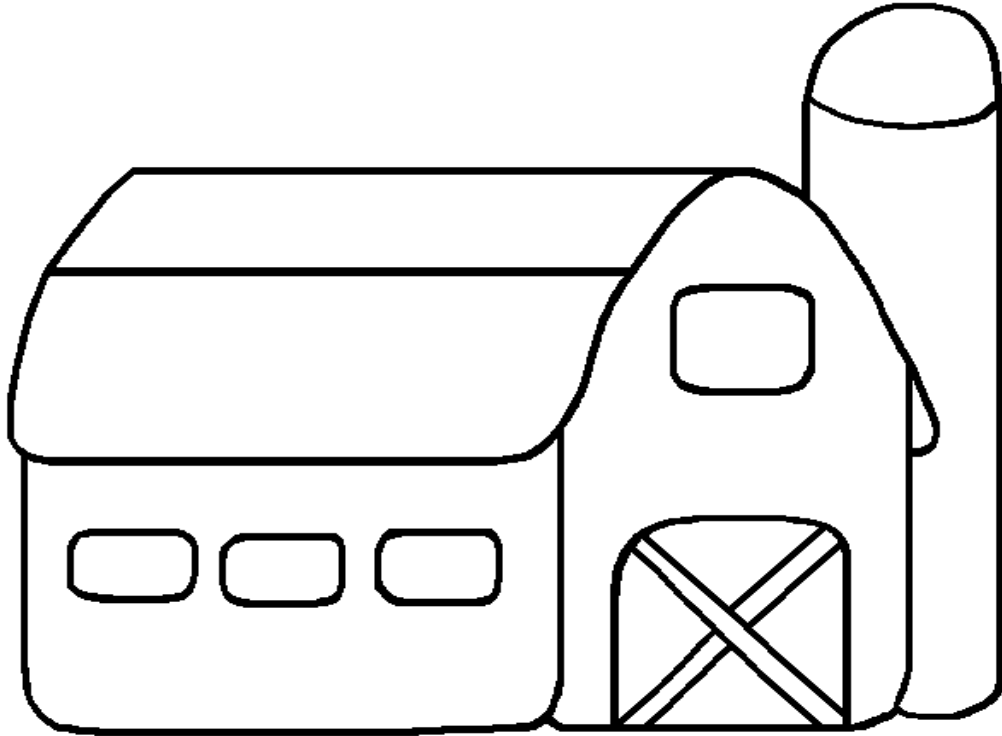

LoveTwoTeach

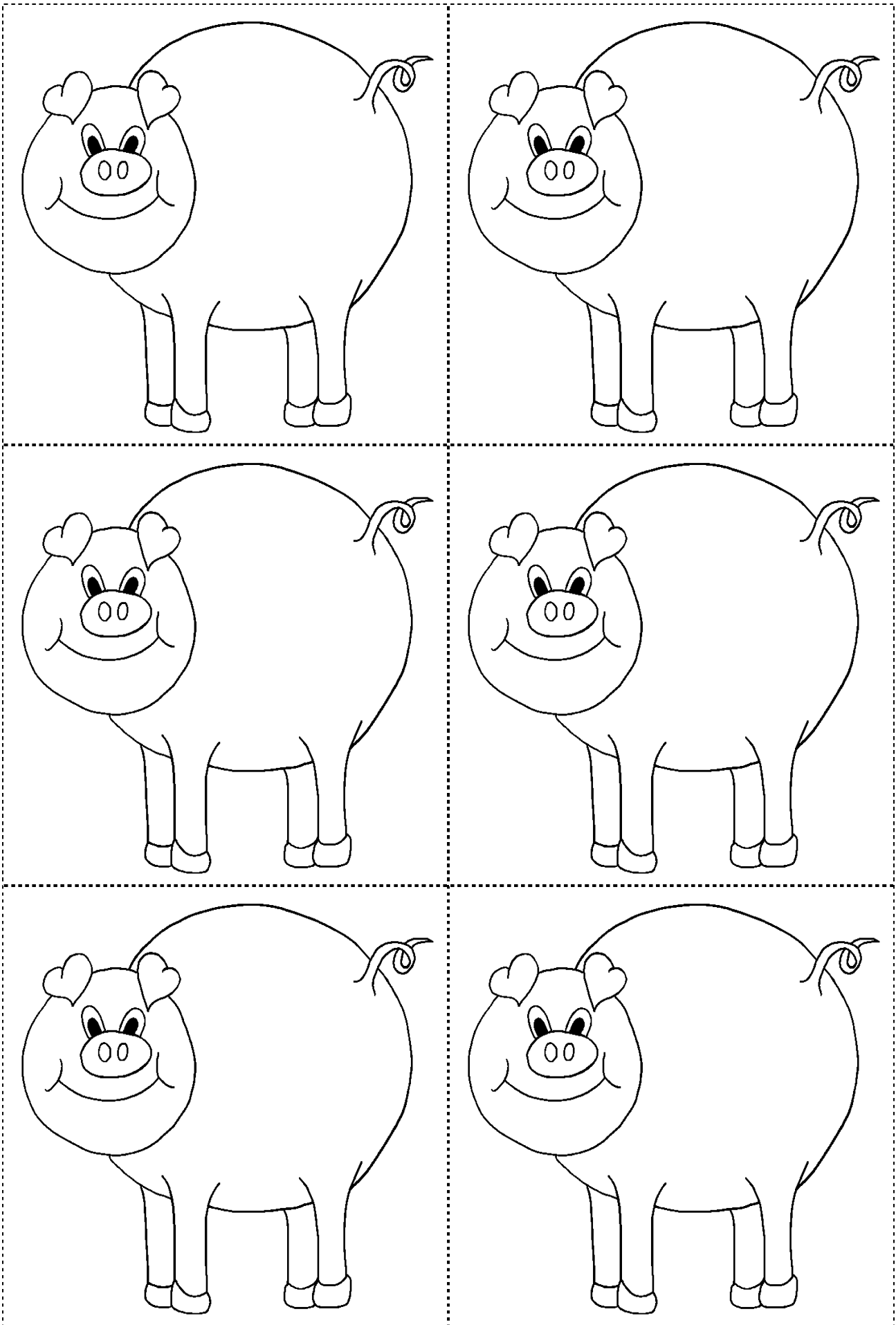

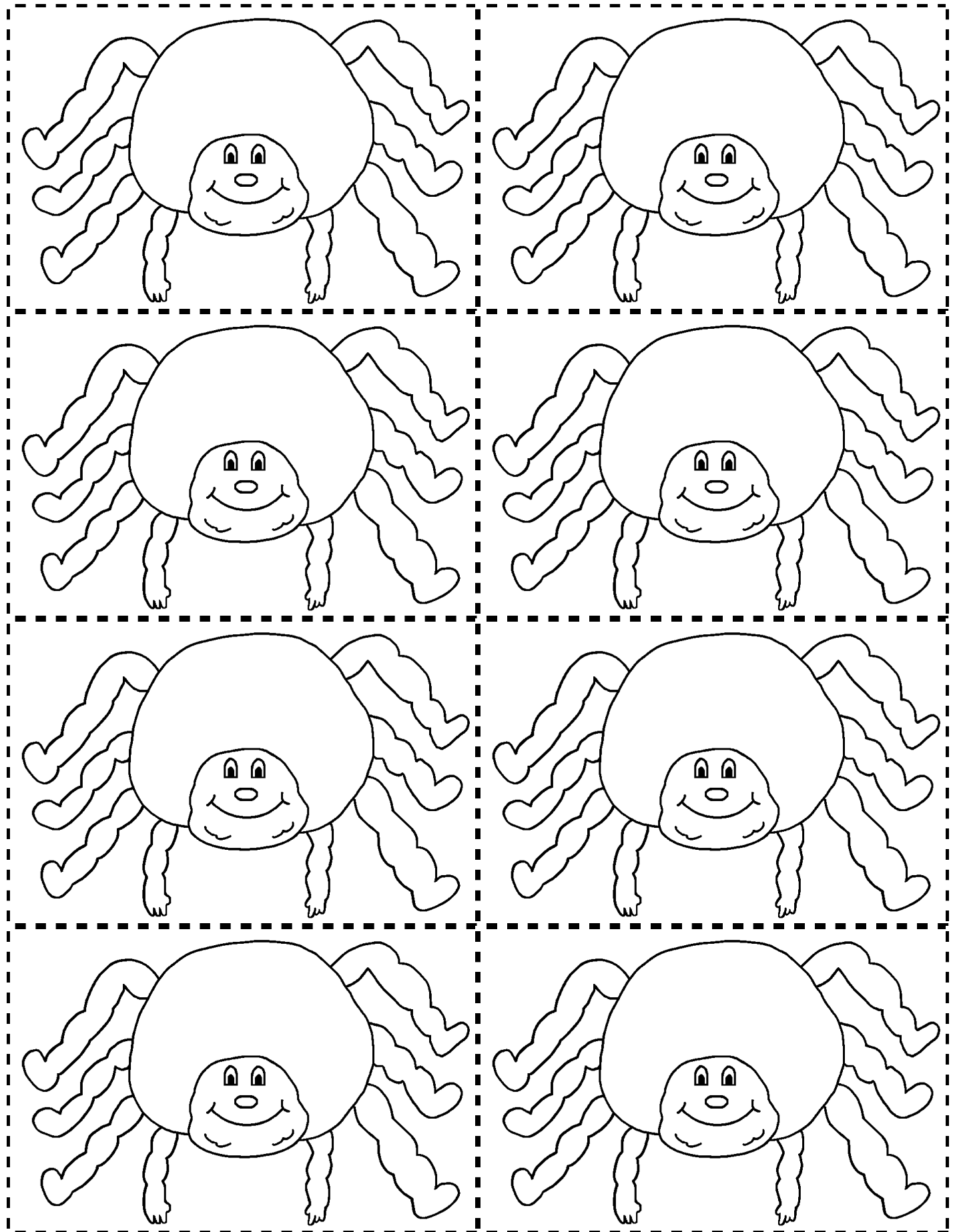



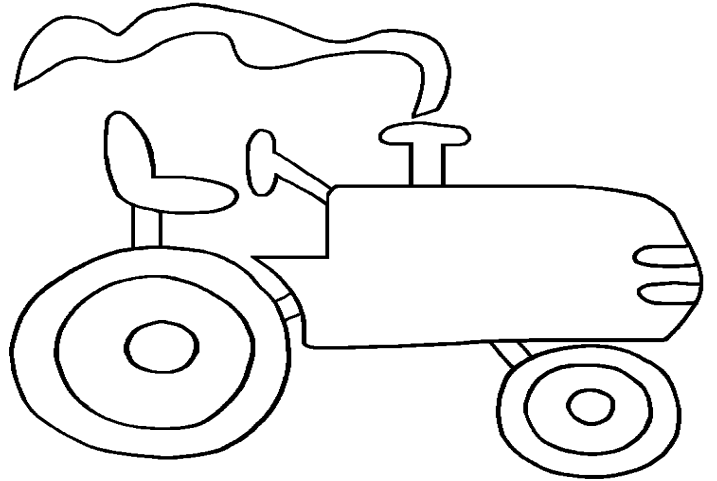
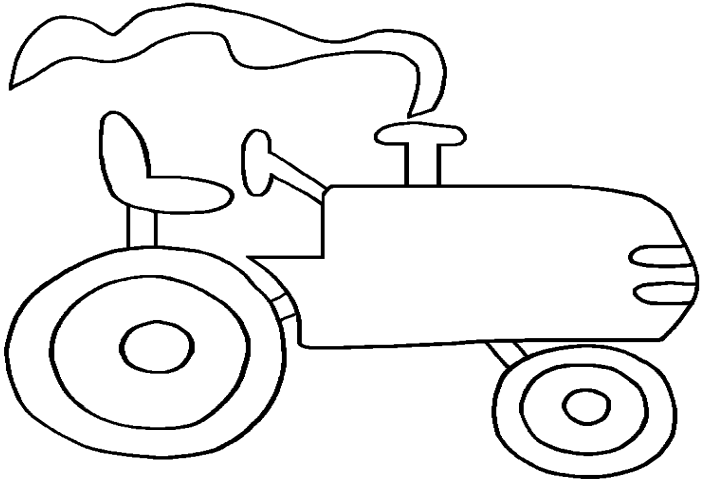
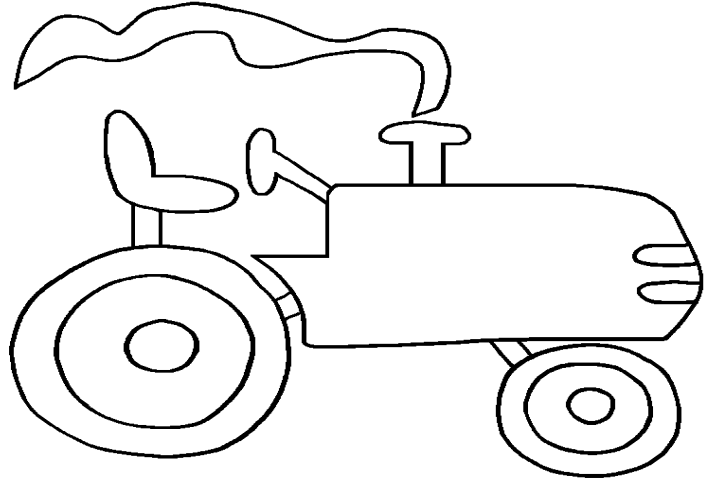
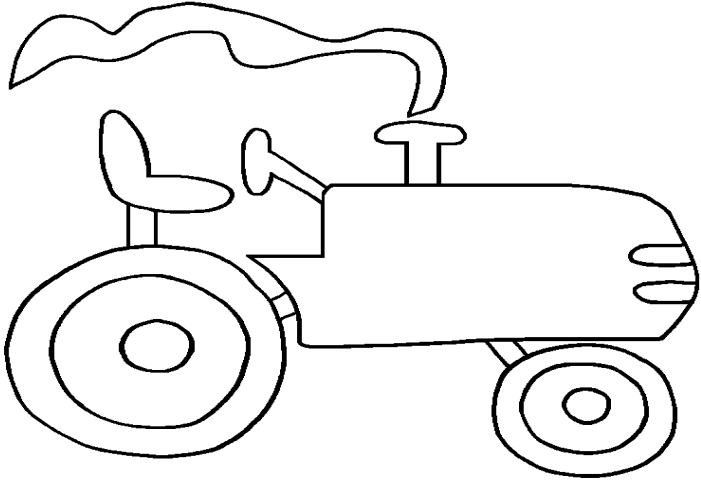
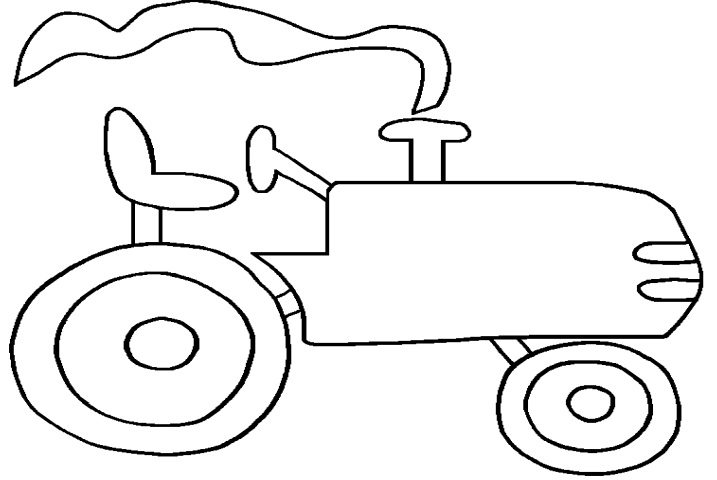
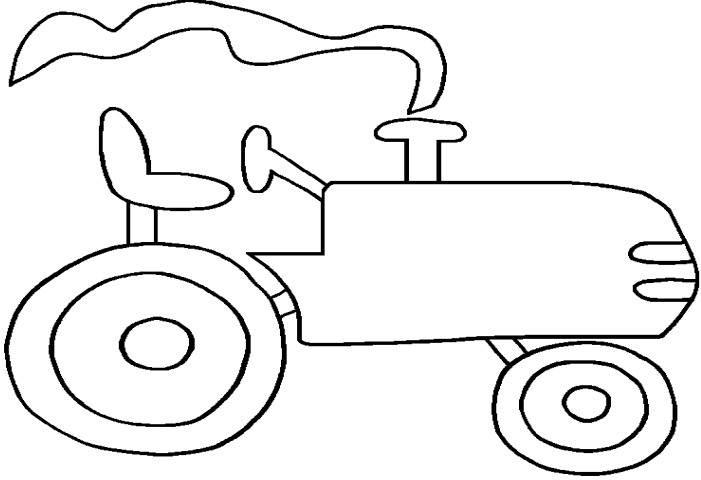
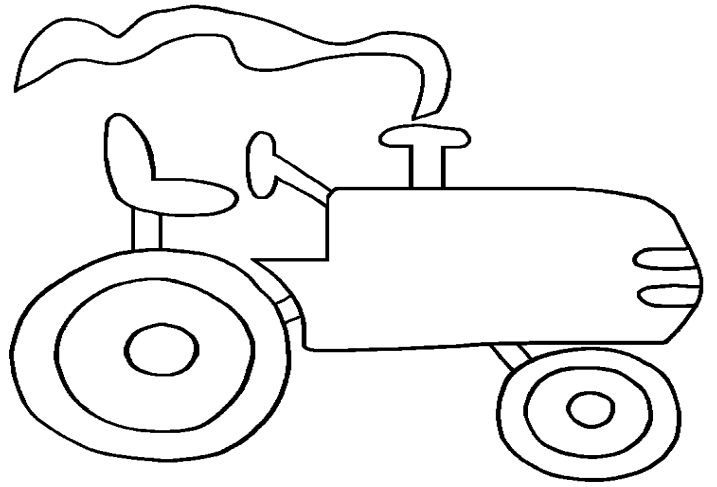
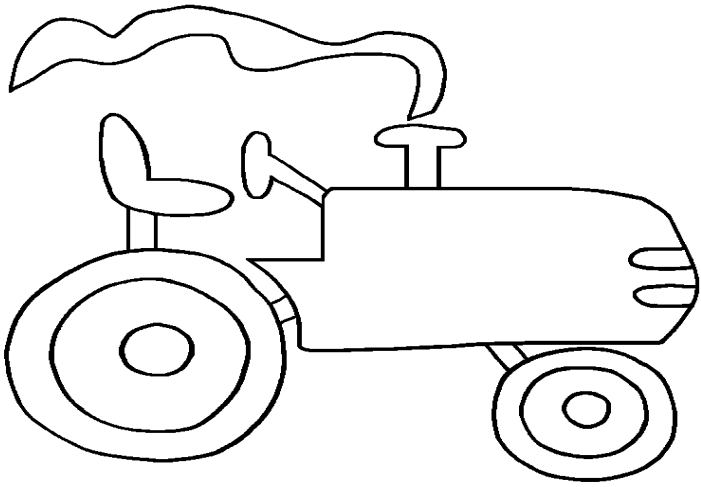

Name: \_\_\_\_\_

## Addition Facts

Cut out the cows to help you find the answers!

$3 + 3 =$

$4 + 1 =$

$6 + 2 =$

$2 + 2 =$

$5 + 5 =$

$1 + 3 =$

$5 + 4 =$

$8 + 2 =$

$7 + 1 =$

$4 + 2 =$

$7 + 3 =$

$9 + 1 =$

$2 + 5 =$

$4 + 3 =$

$2 + 1 =$

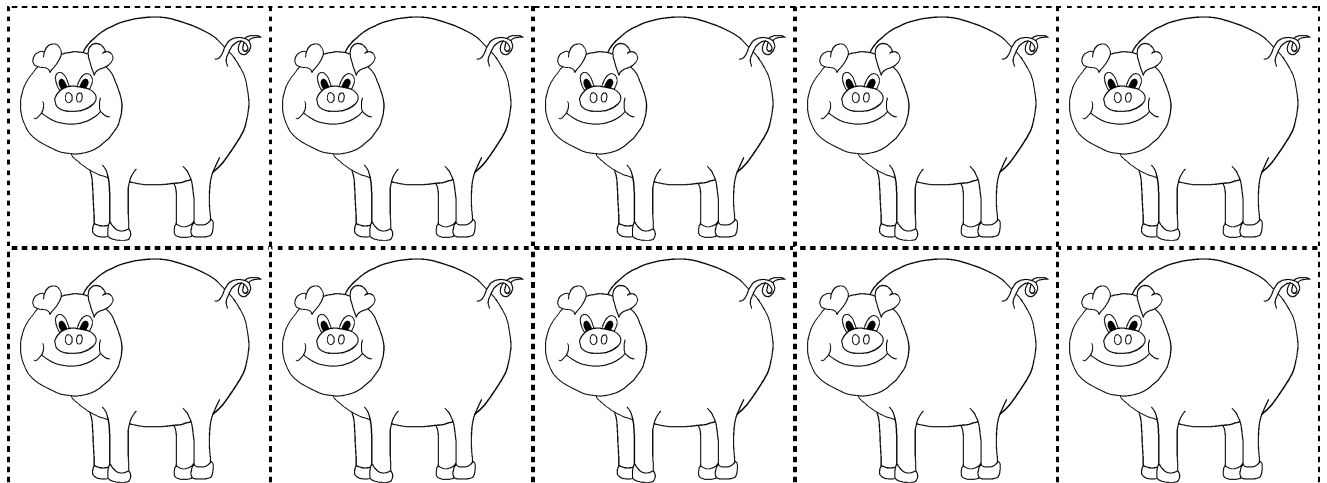

Name: \_\_\_\_\_

Date: \_\_\_\_\_

Draw the hands on the clock to match the time.

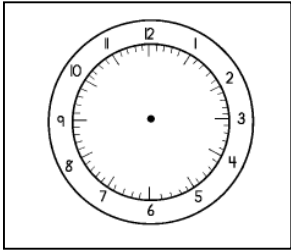

2:00

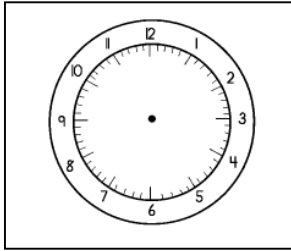

3:00

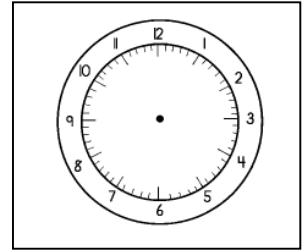

8:00

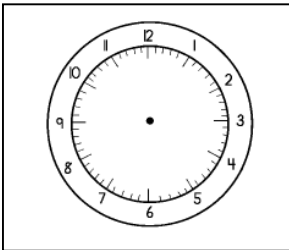

9:00

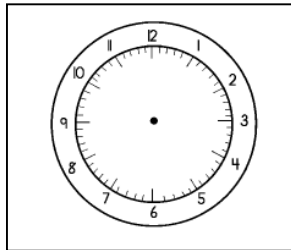

12:00

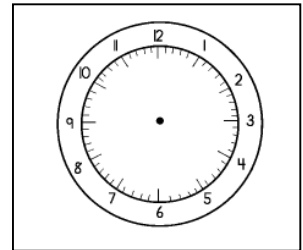

4:00

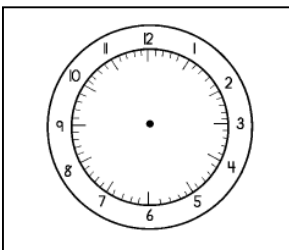

3:00

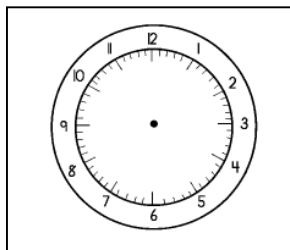

7:00

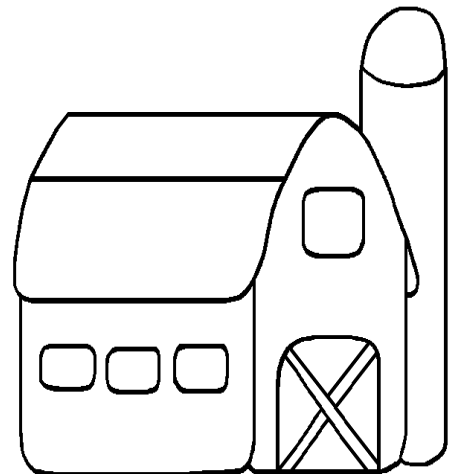

# The Farm

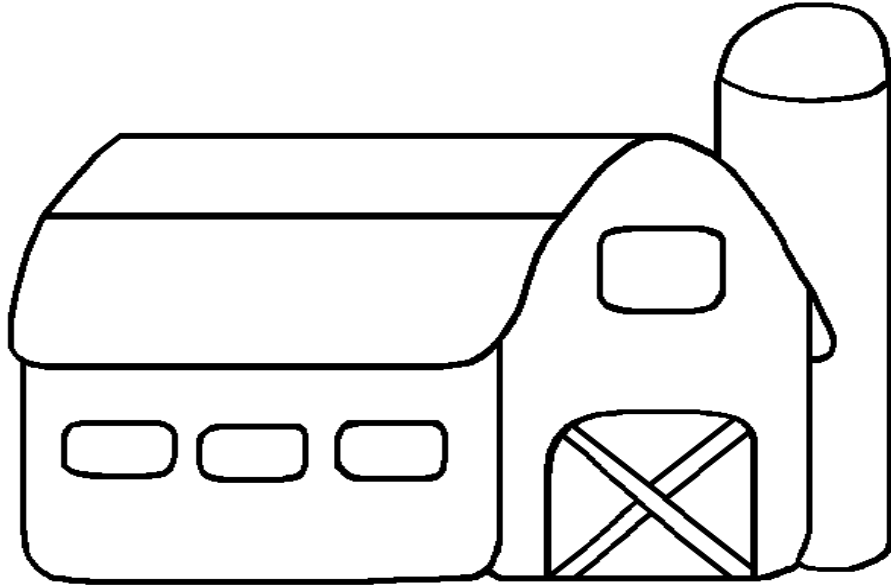

By: \_\_\_\_\_

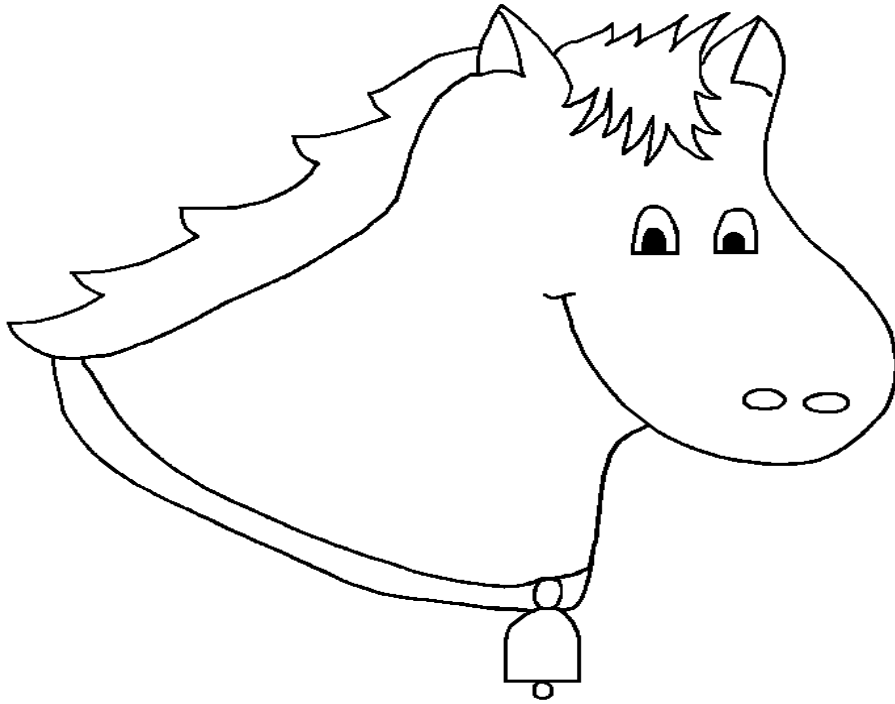

Can you see the horse?

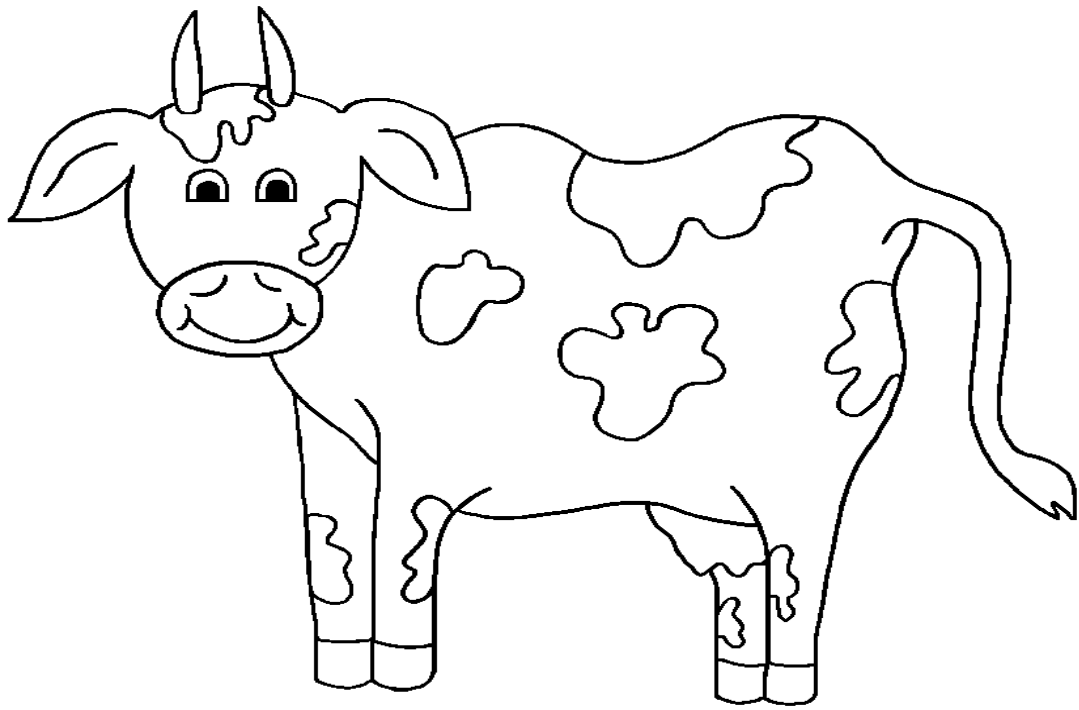

Can you see the cow?

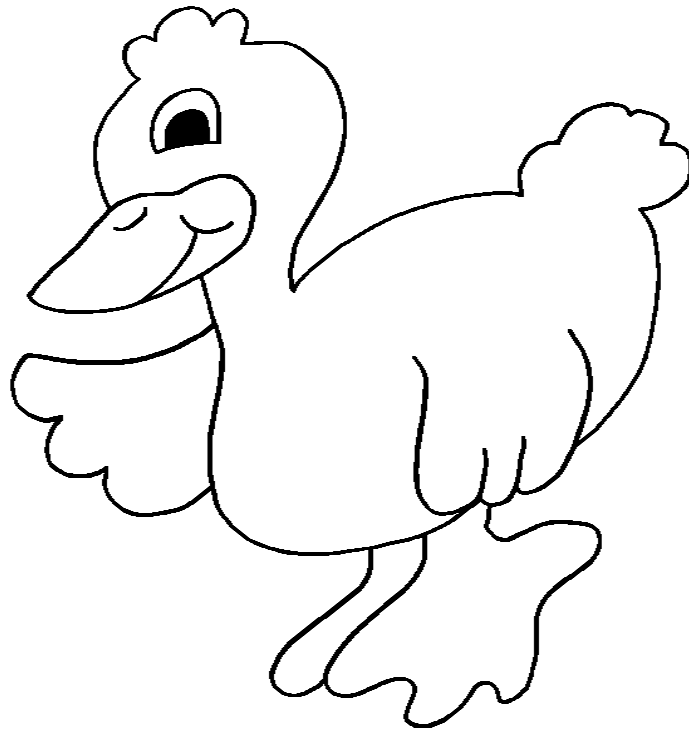

Can you see the duck?

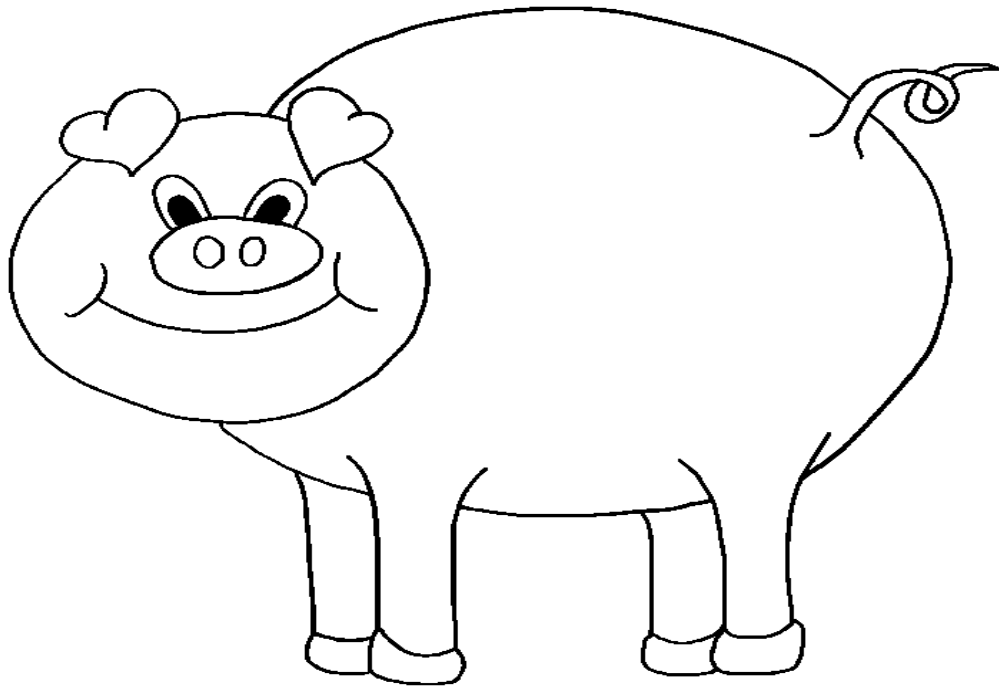

Can you see the pig?

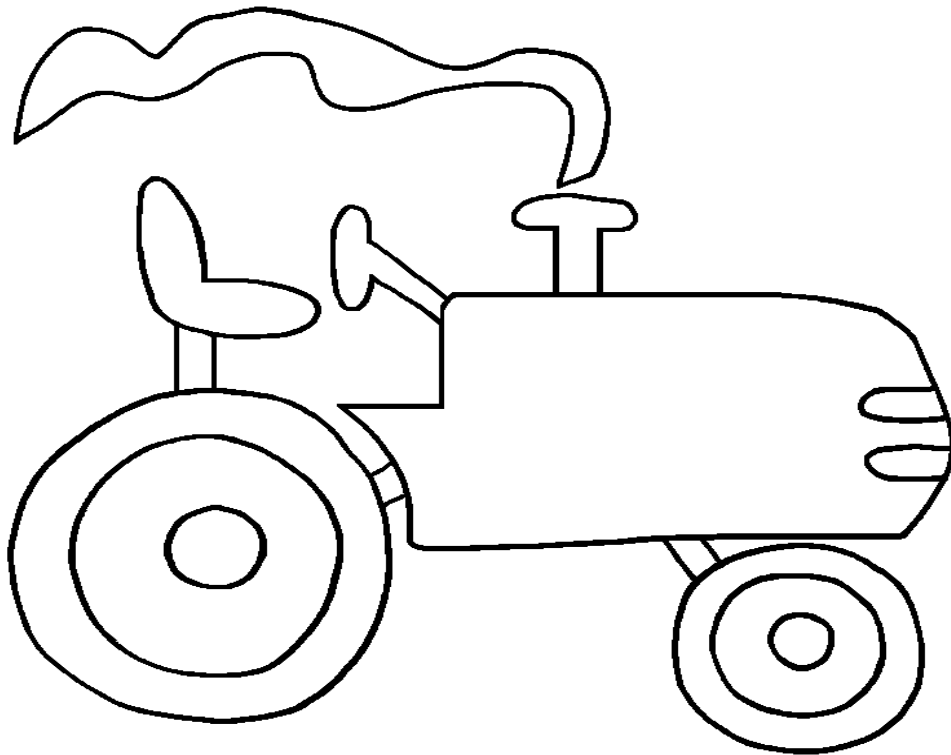

Can you see the tractor?

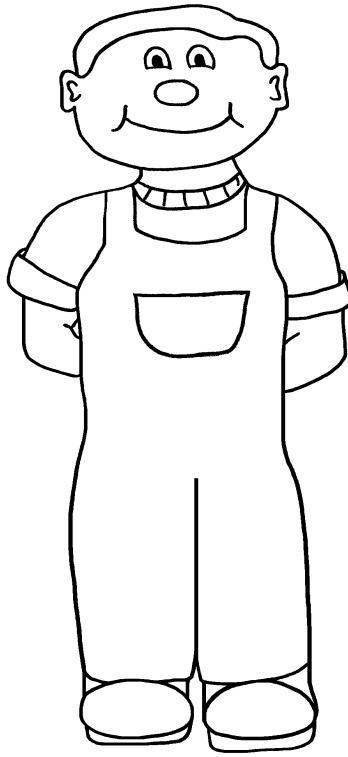

Can you see the farmer?

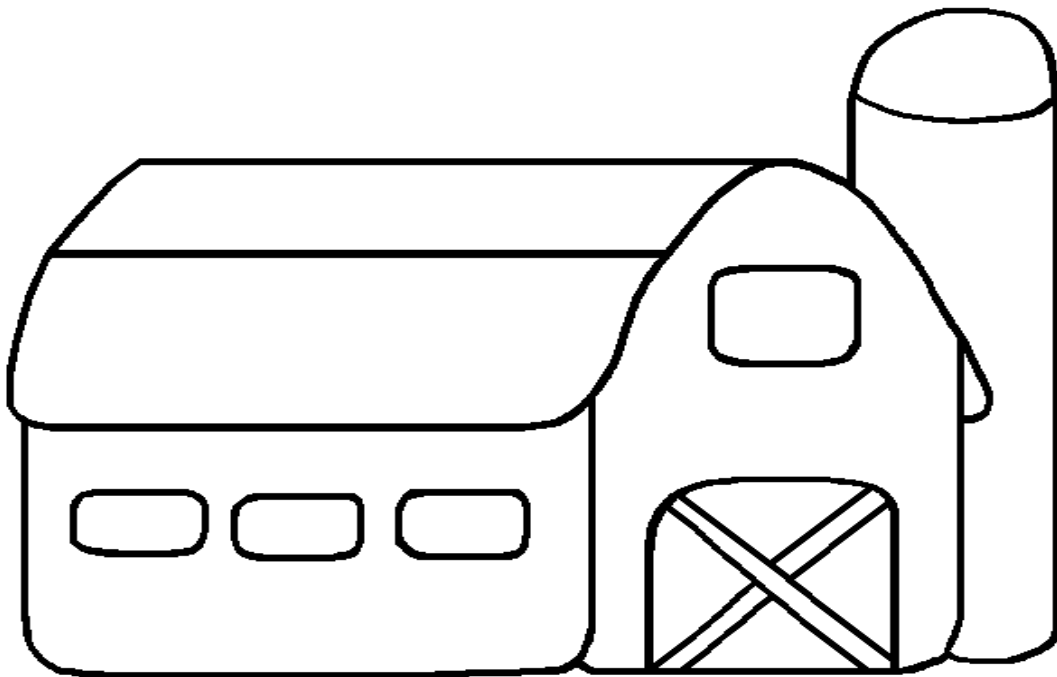

Can you see the farm?

# I See Farm Animals

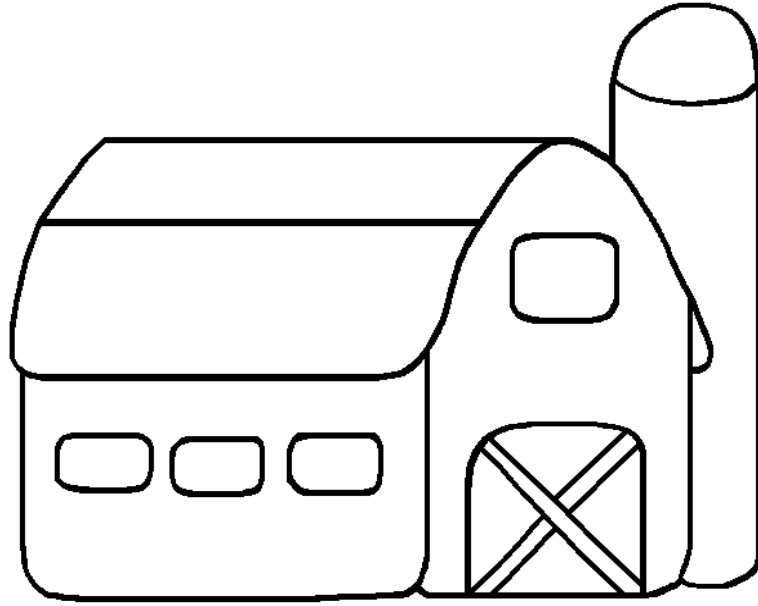

By: \_\_\_\_\_

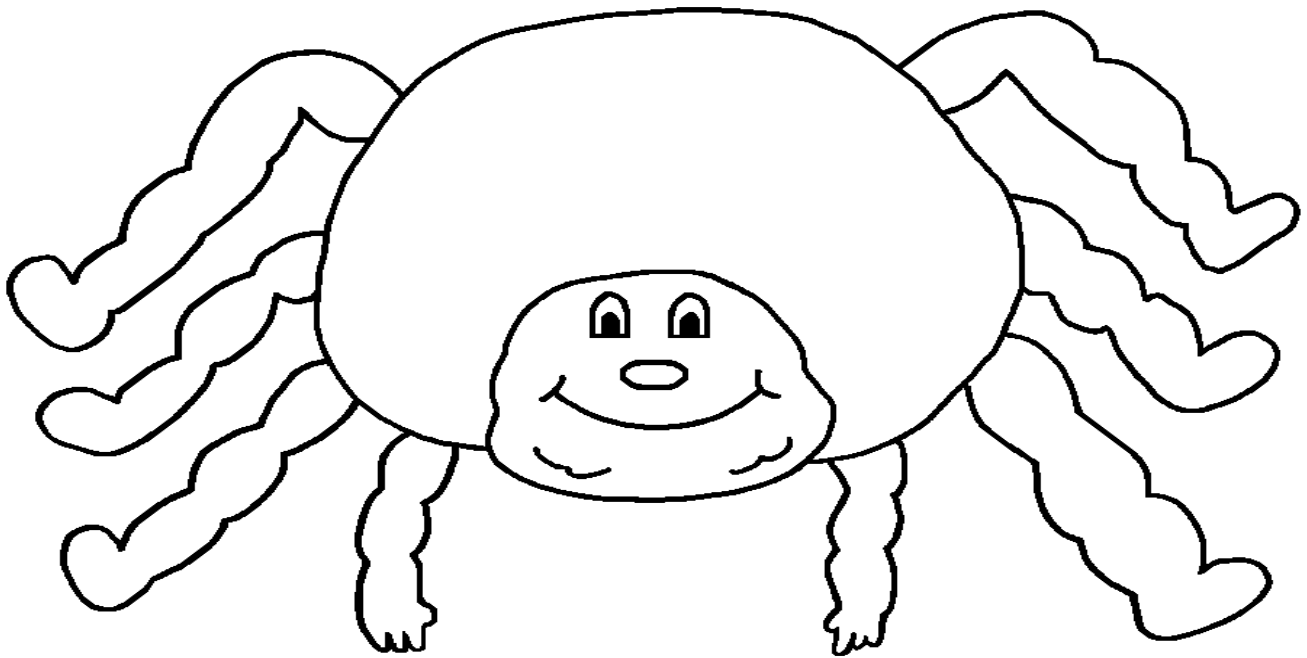

I see one spider.

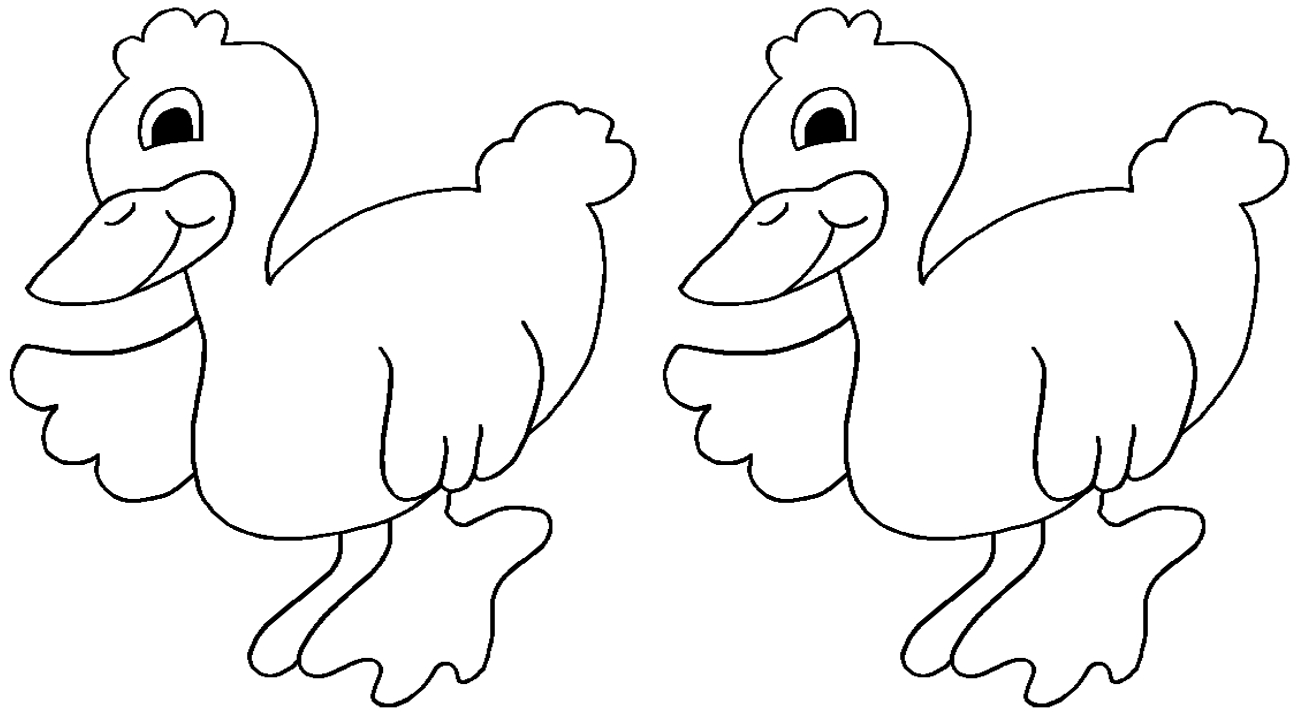

I see two ducks.

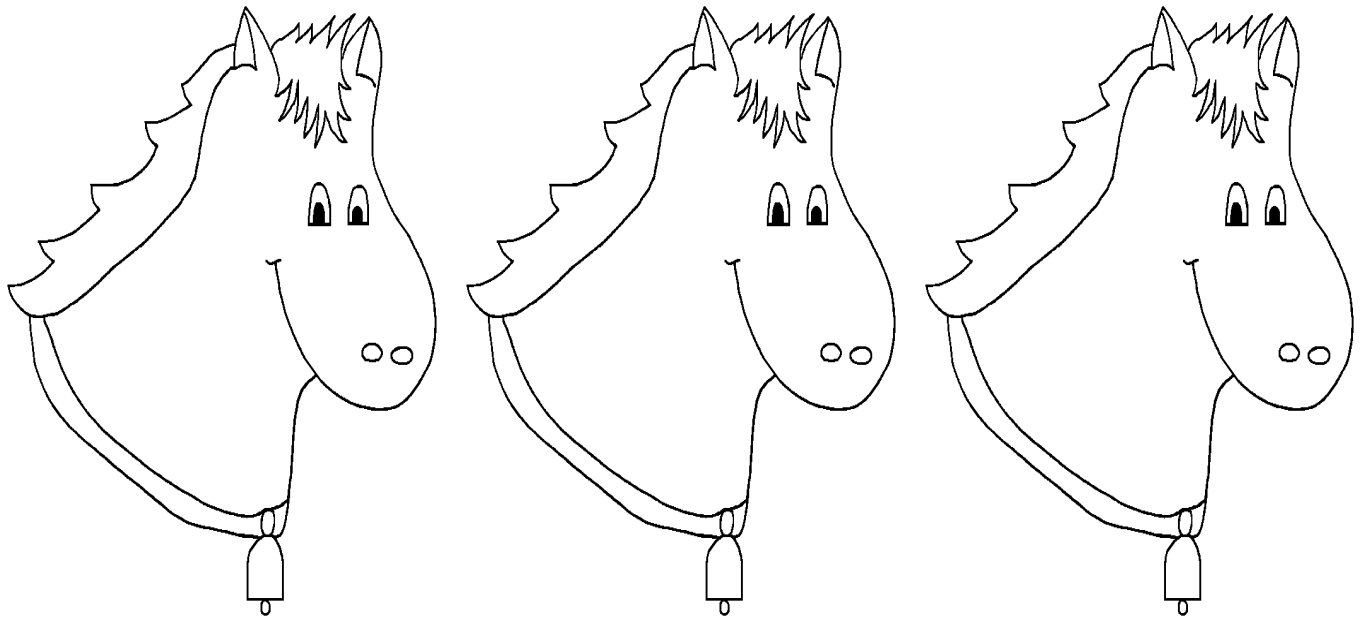

I see three horses.

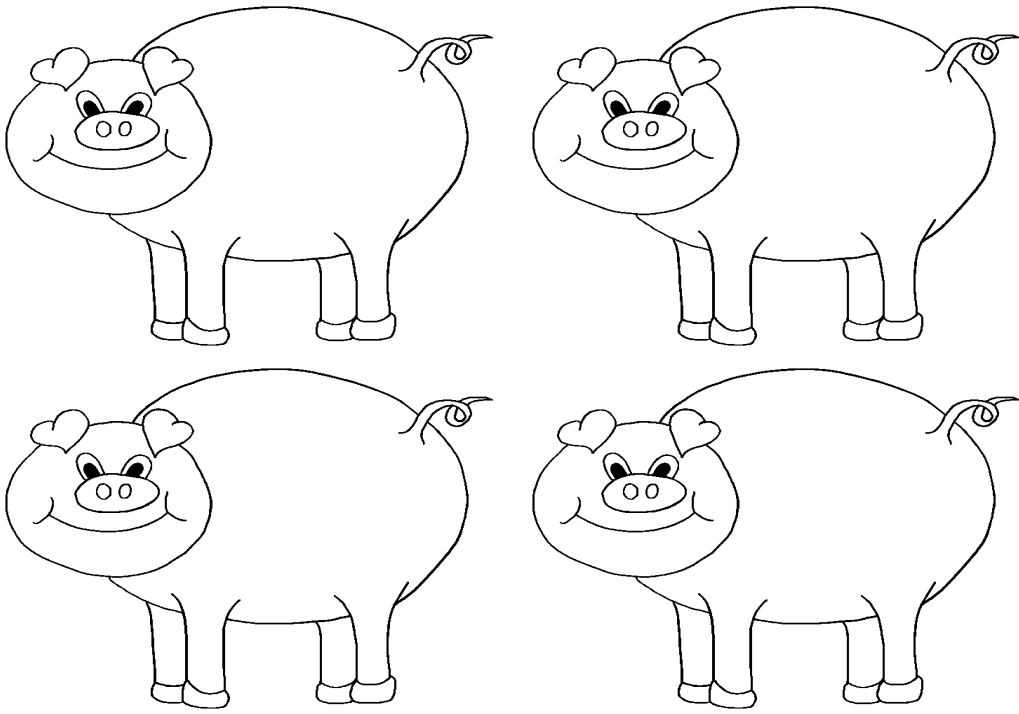

I see four pigs.

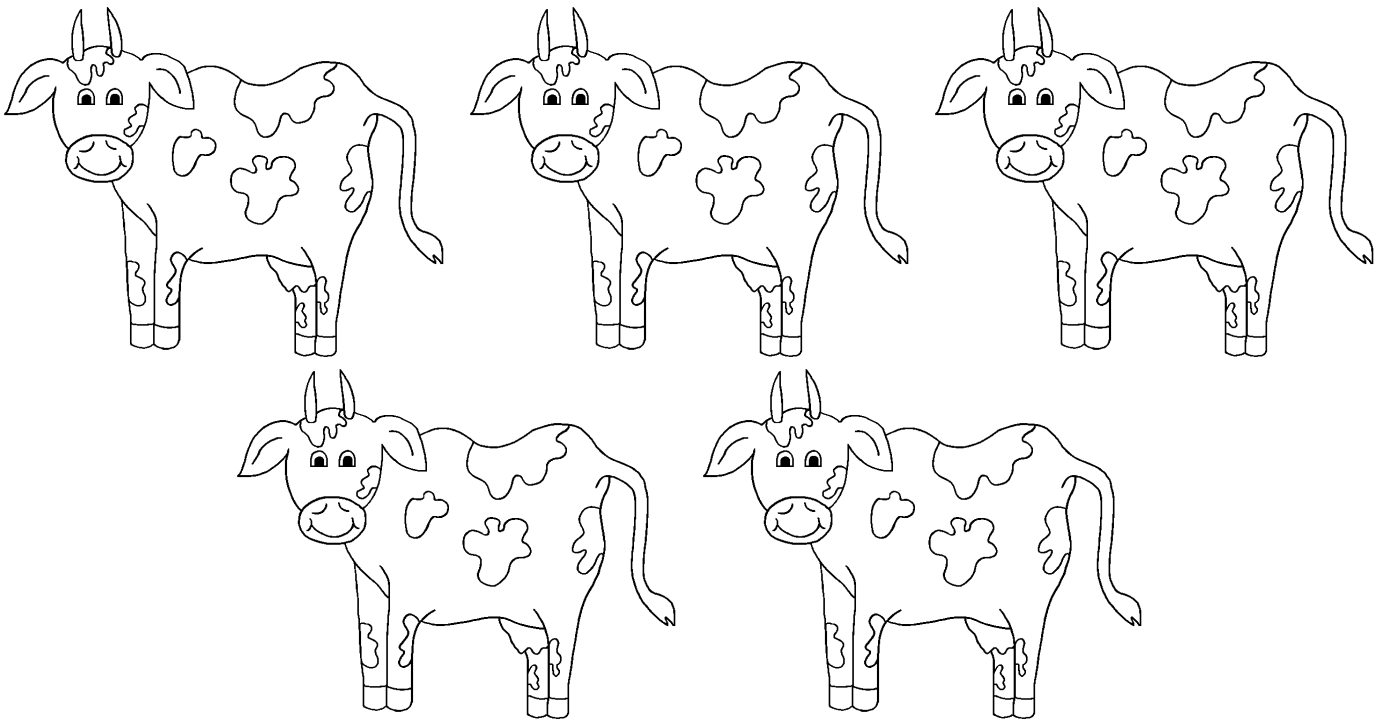

I see five cows.

# I See Pigs

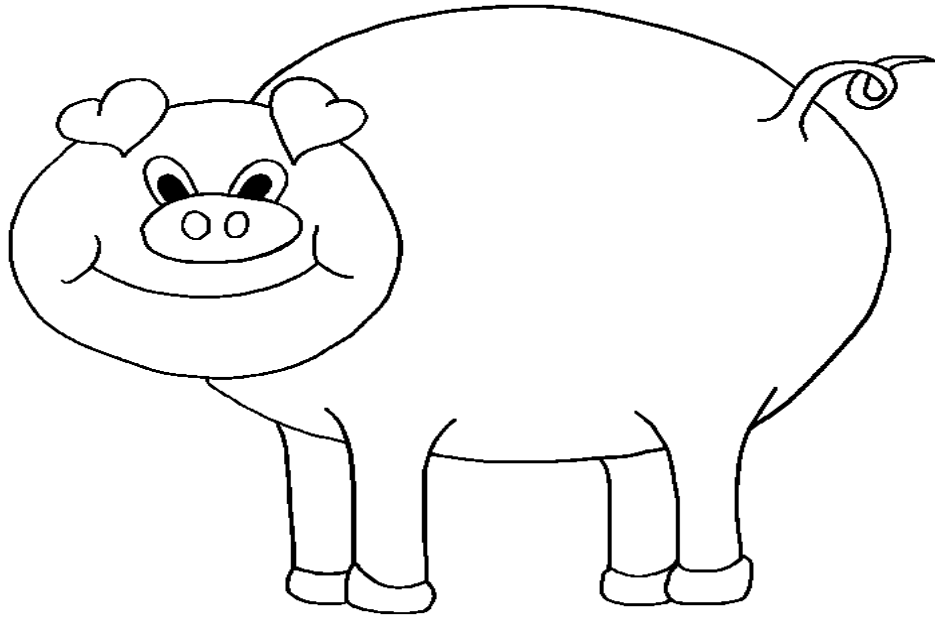

By: \_\_\_\_\_

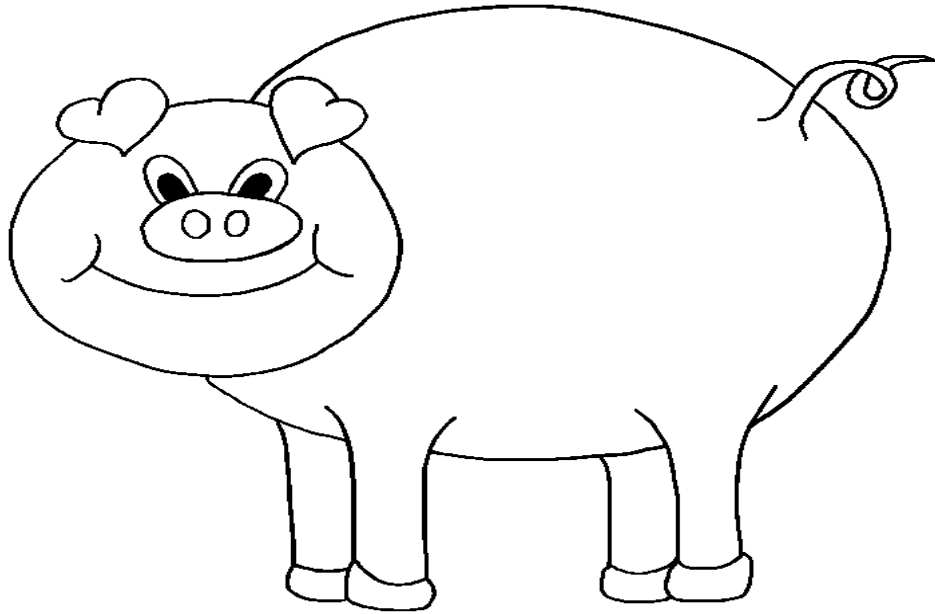

I see one pig.

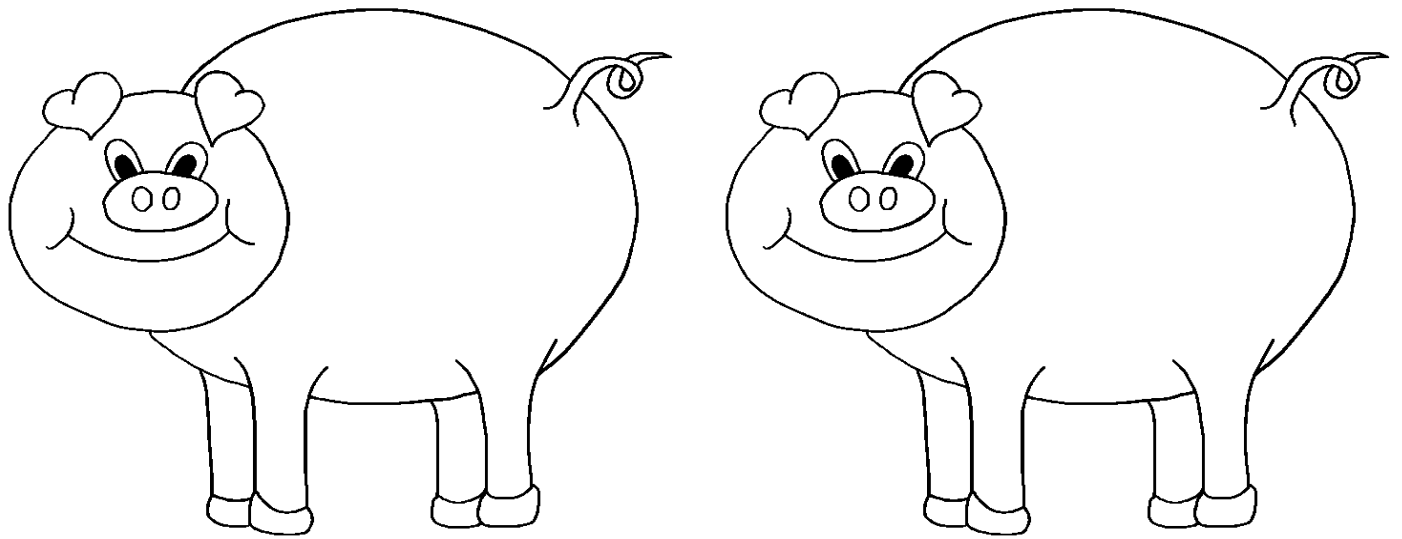

I see two pigs.

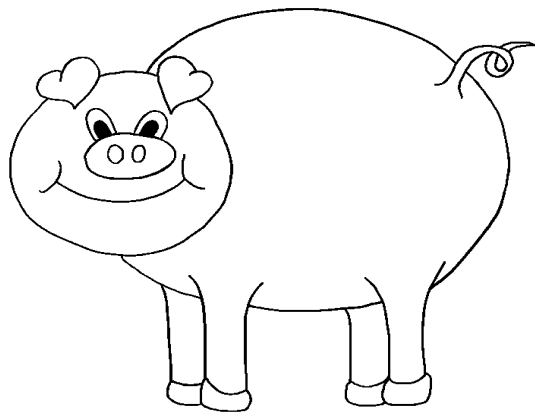
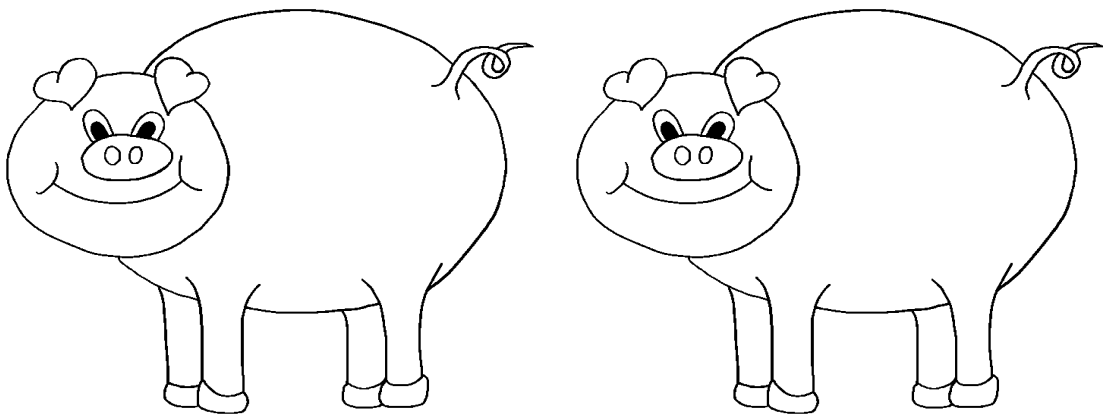

I see three pigs.

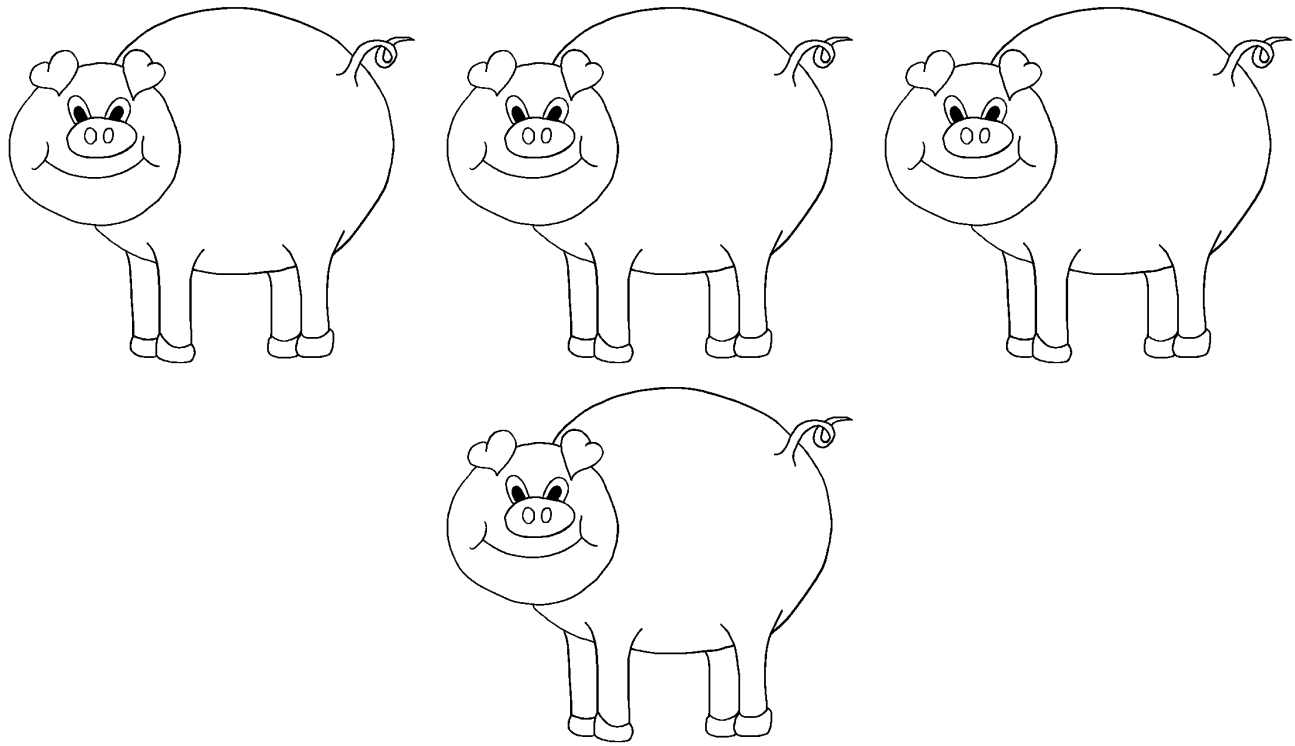

I see four pigs.

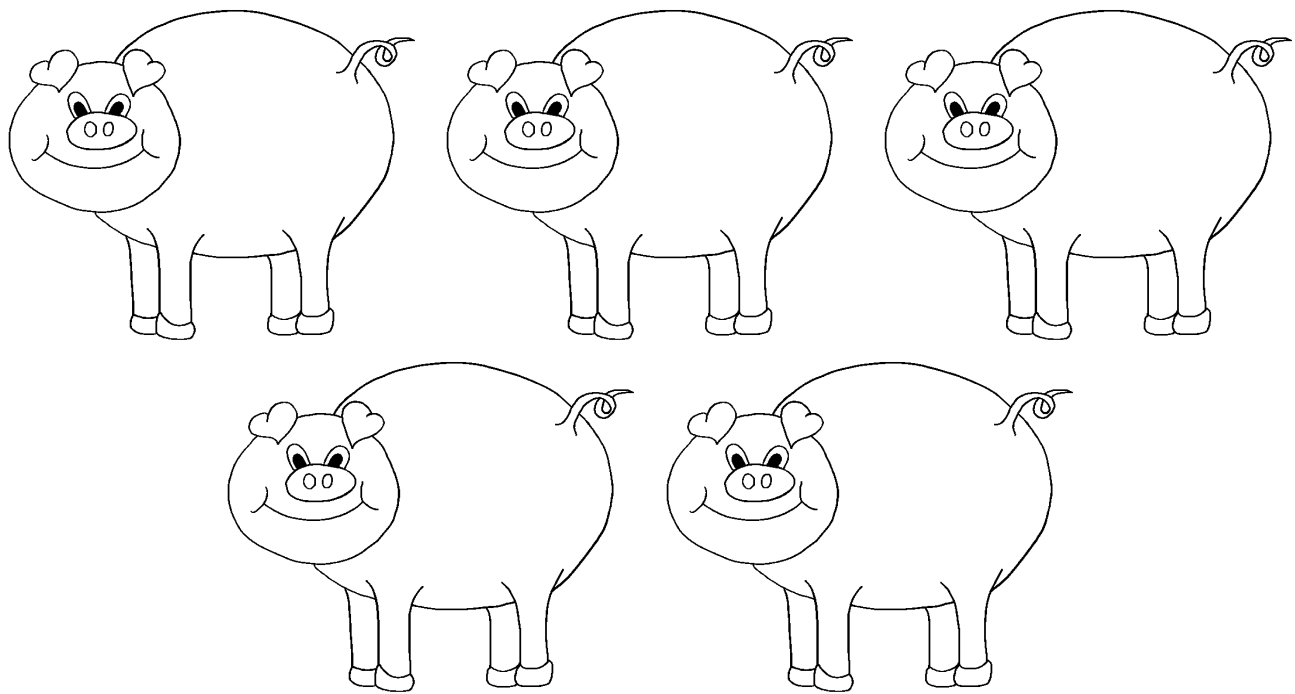

I see five pigs.

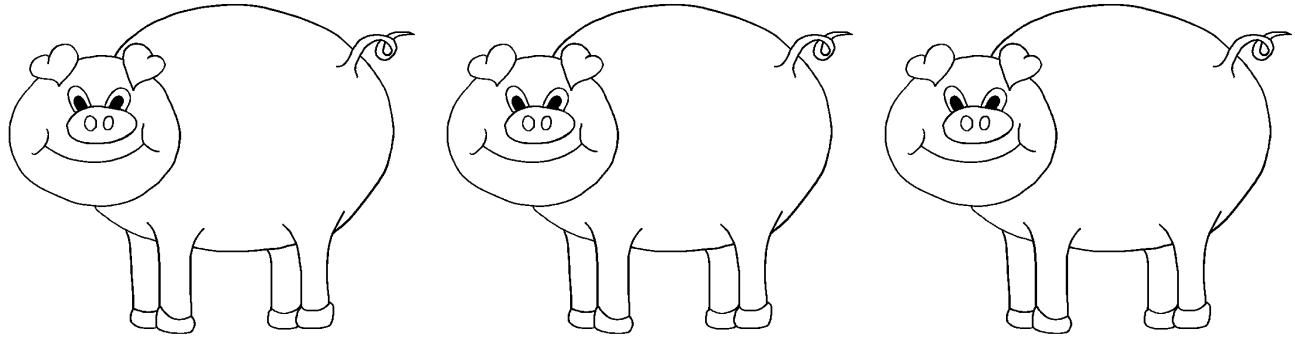
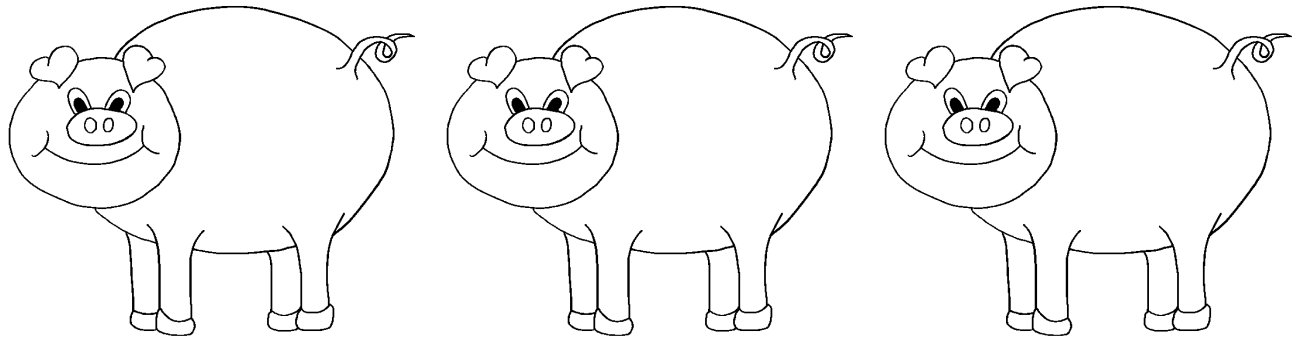

I see six pigs.

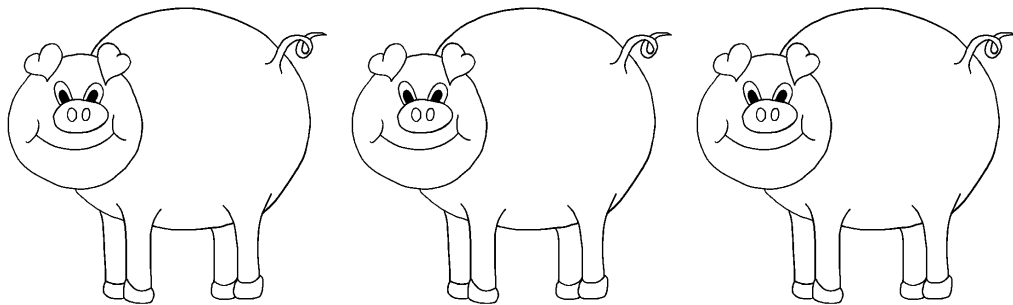
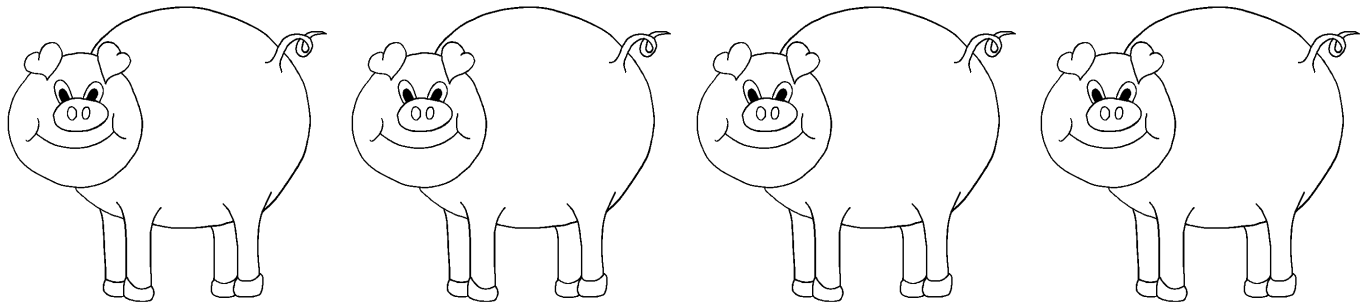

I see seven pigs.

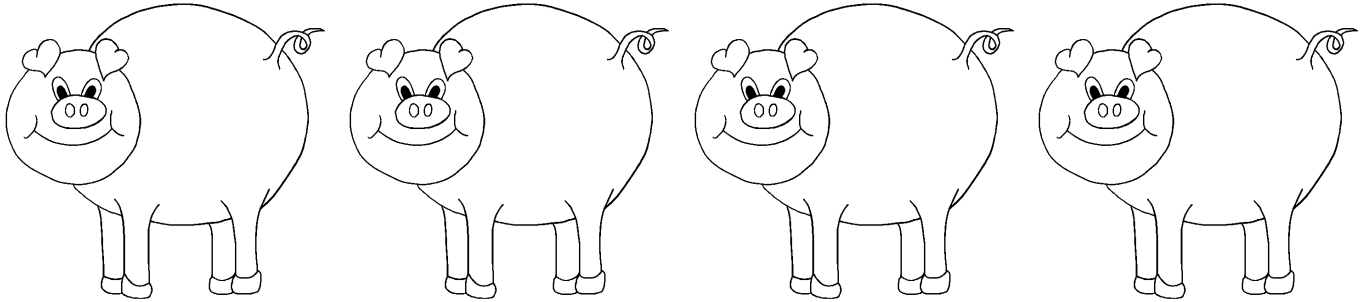
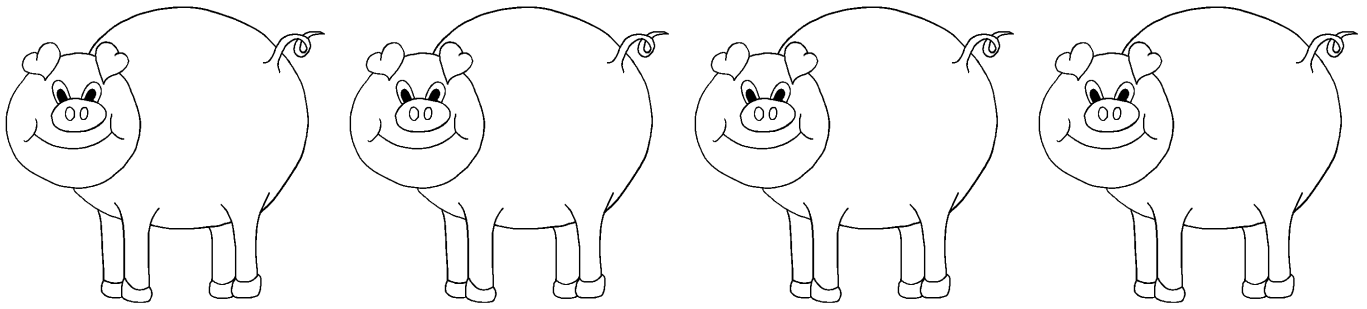

I see eight pigs.

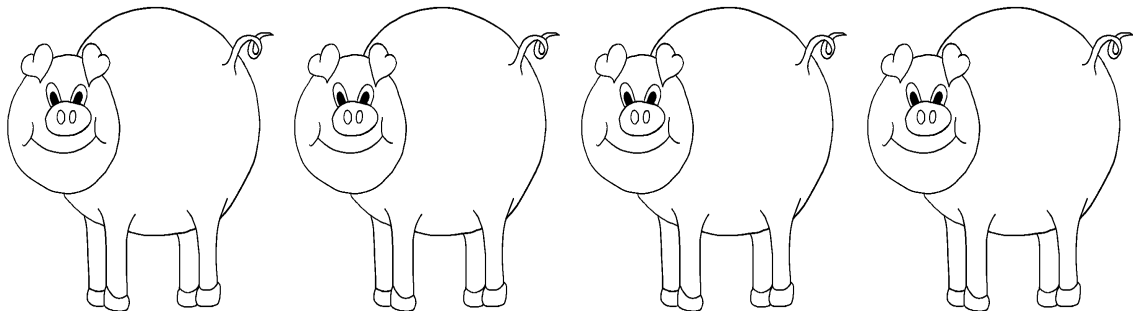
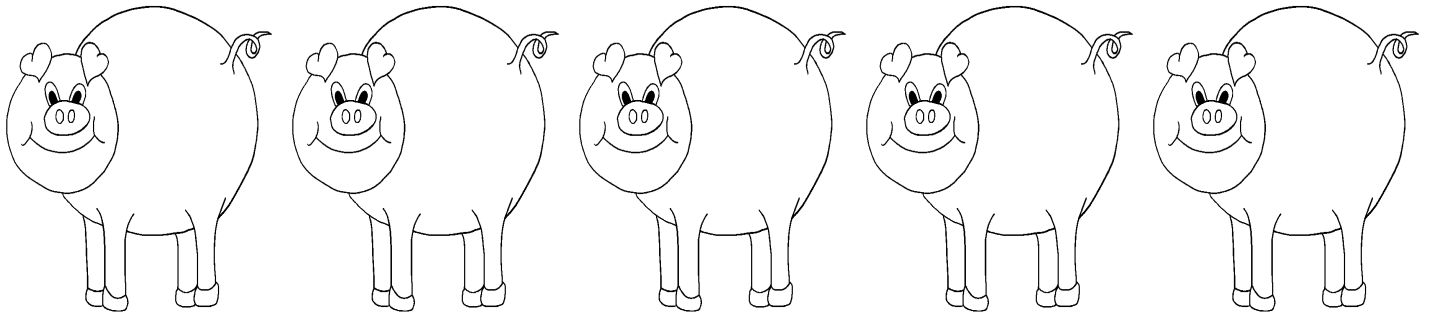

I see nine pigs.

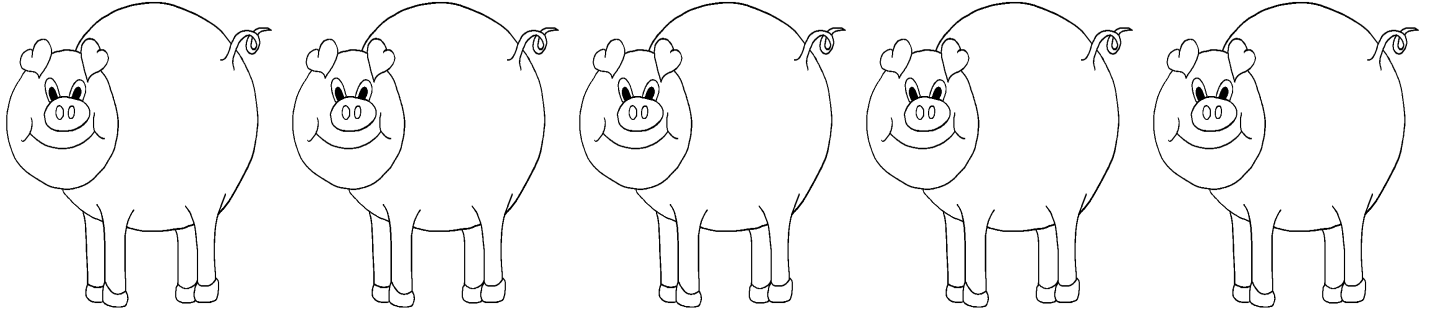
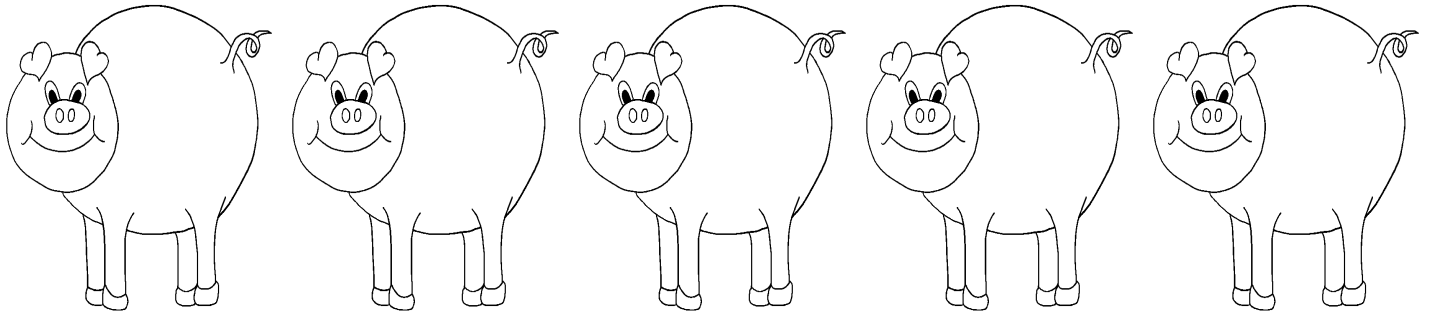

I see ten pigs.

# I See Pigs

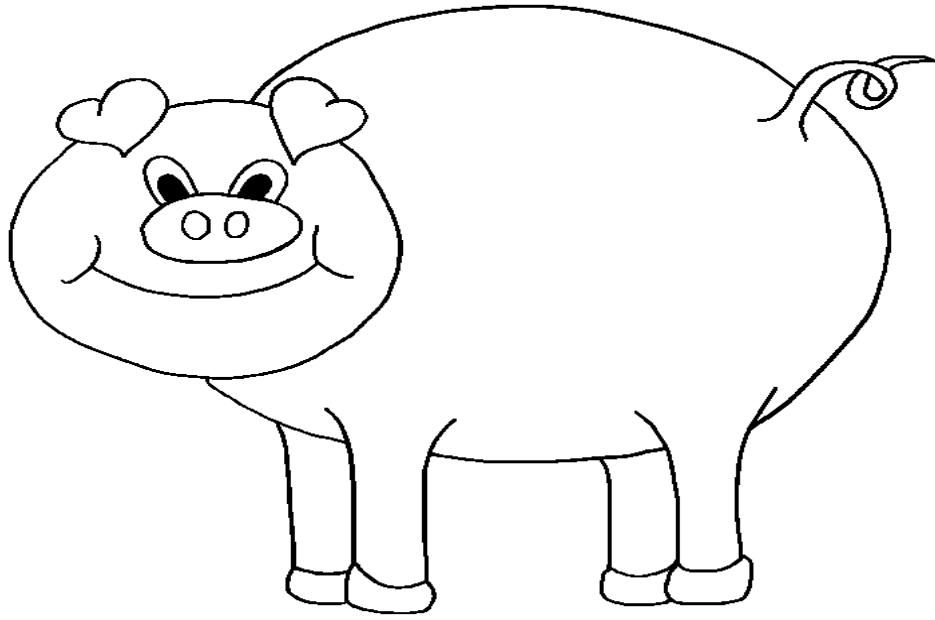

By: \_\_\_\_\_

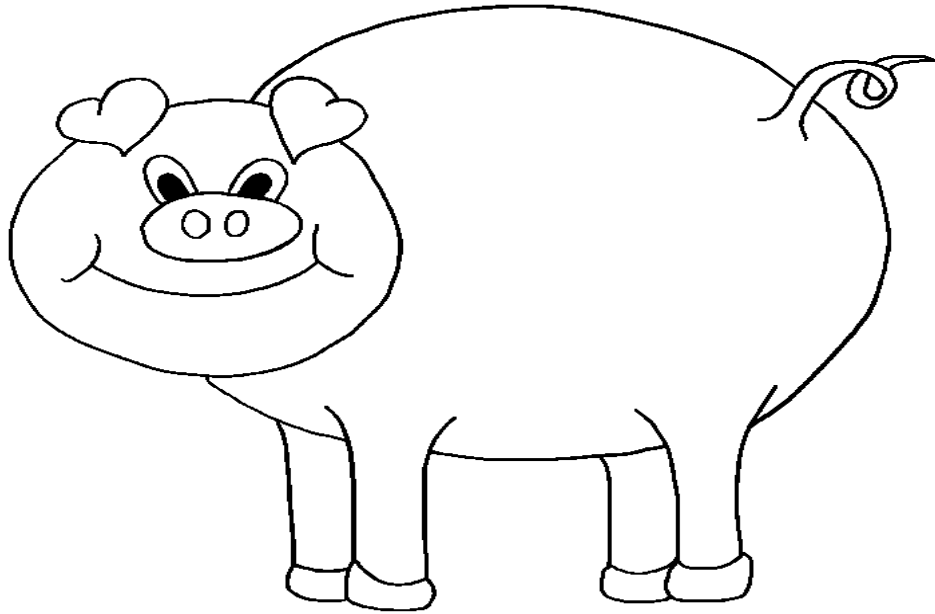

I see | pig.

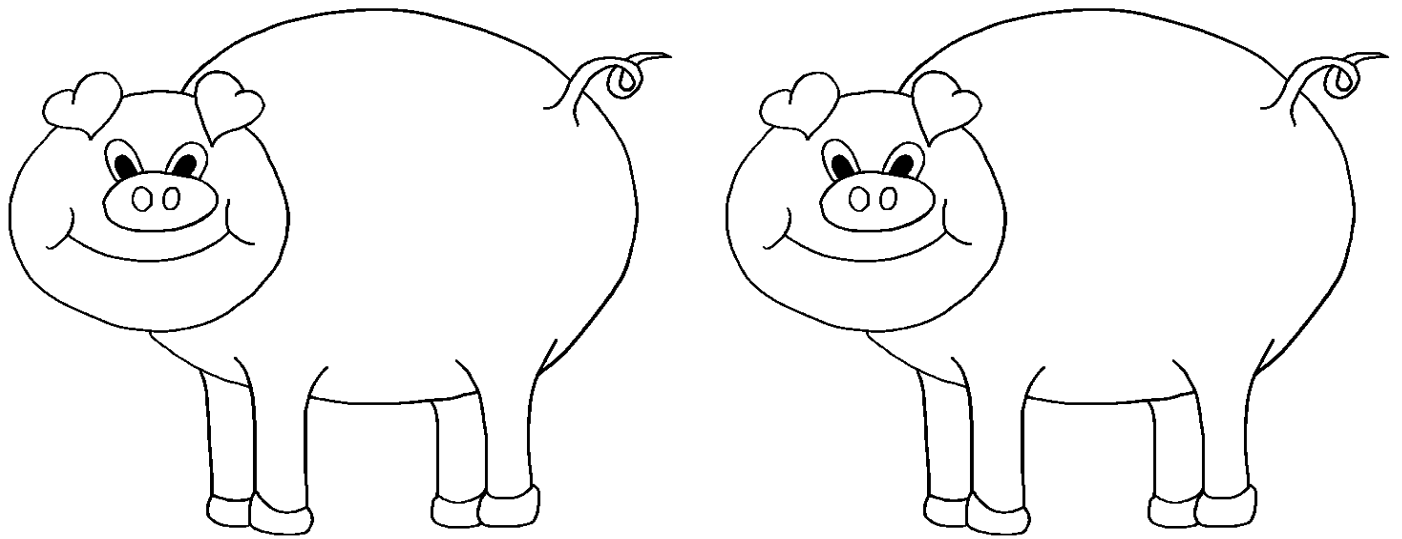

I see 2 pigs.

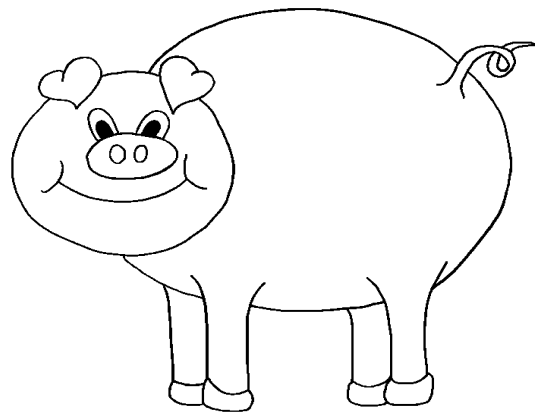
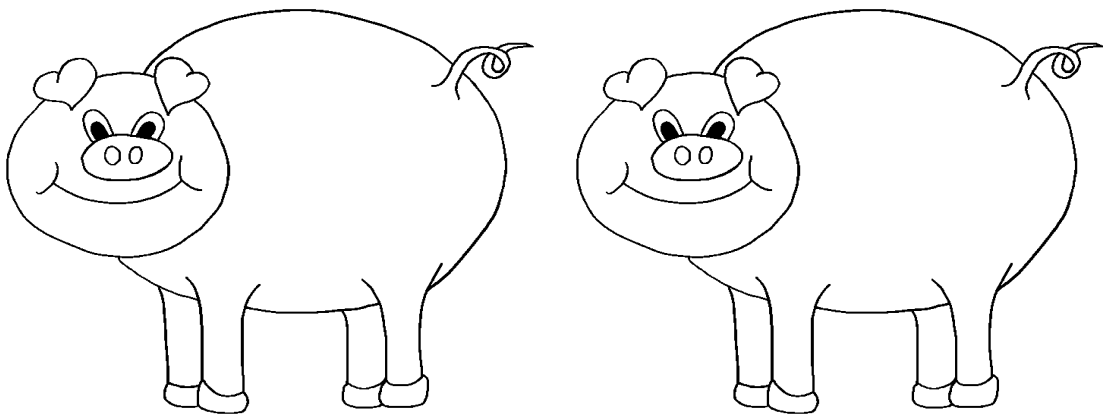

I see 3 pigs.

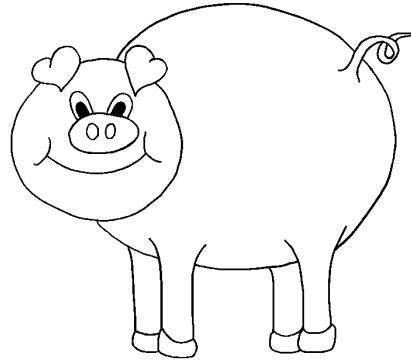
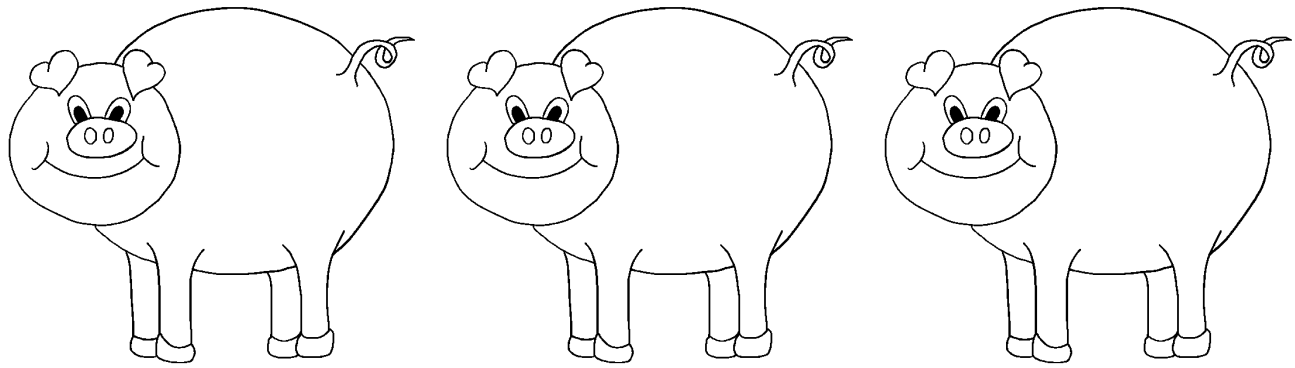

I see 4 pigs.

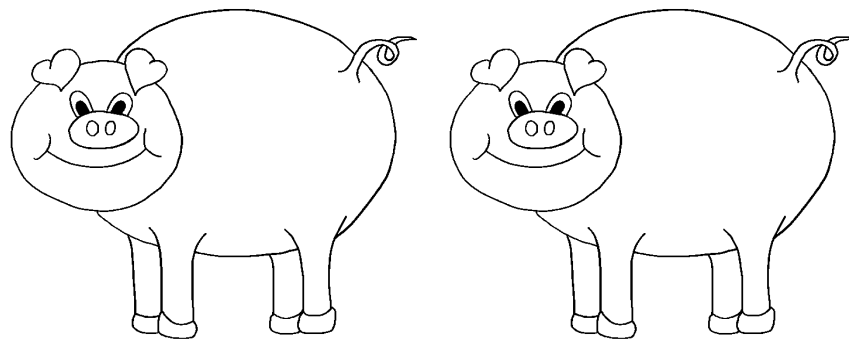
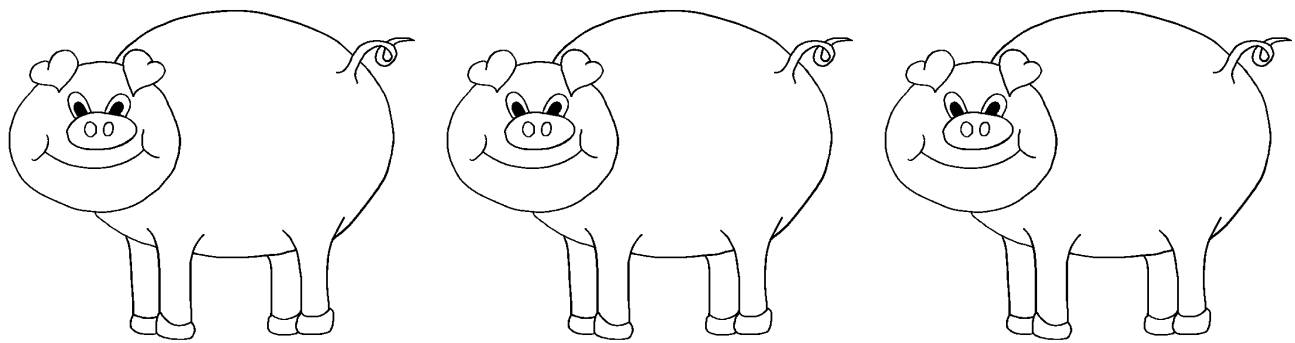

I see 5 pigs.

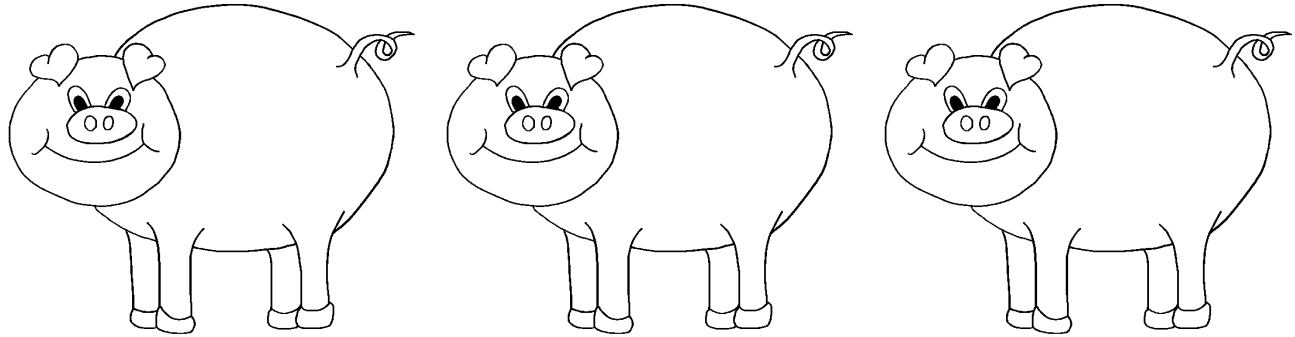
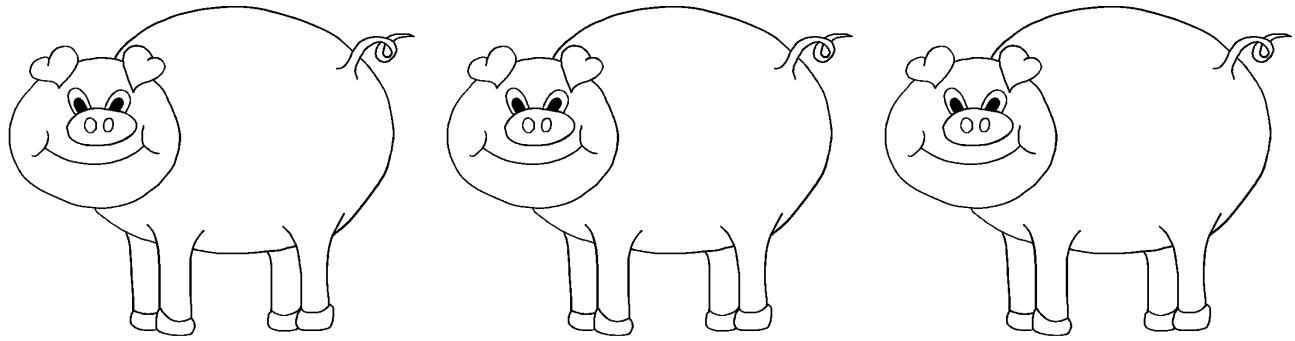

I see 6 pigs.

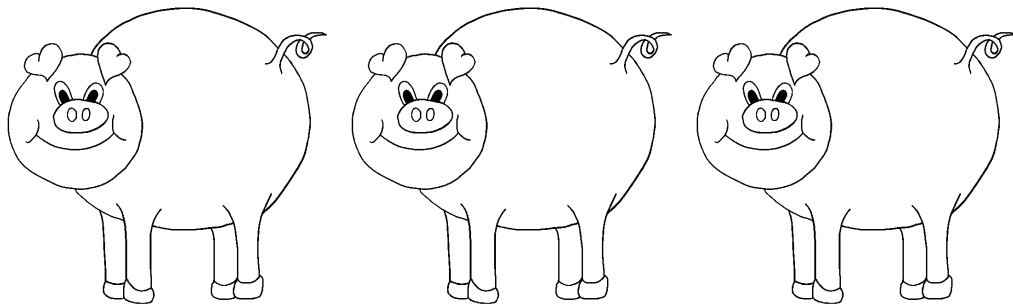
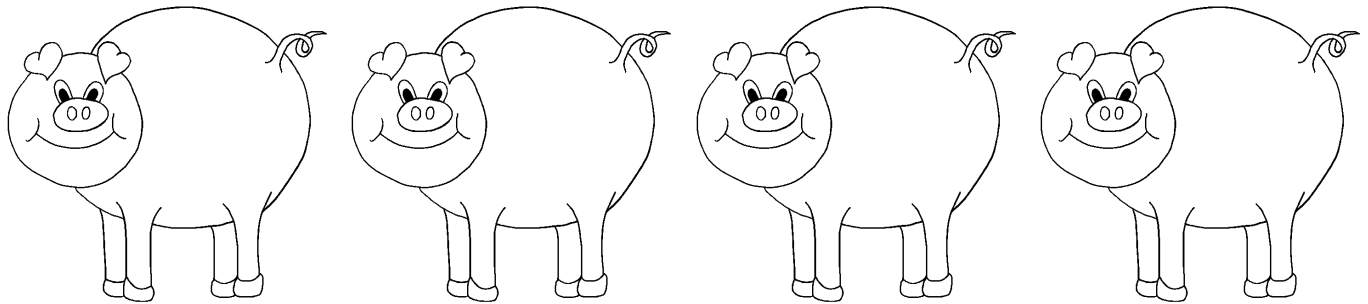

I see 7 pigs.

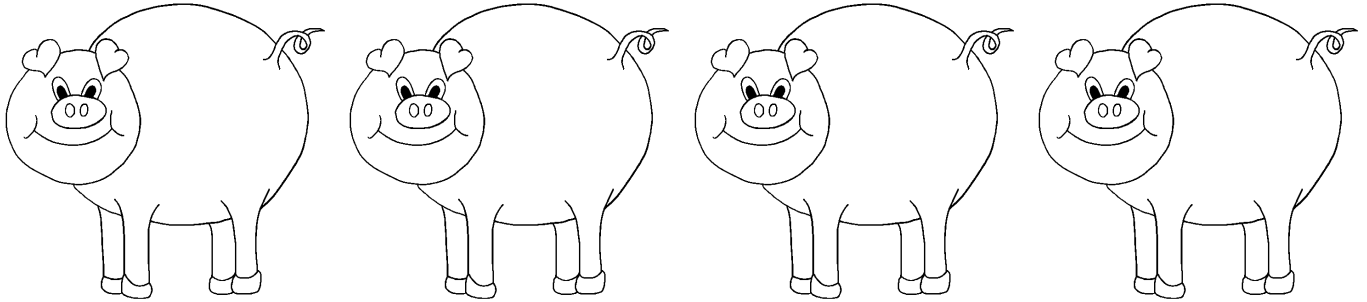
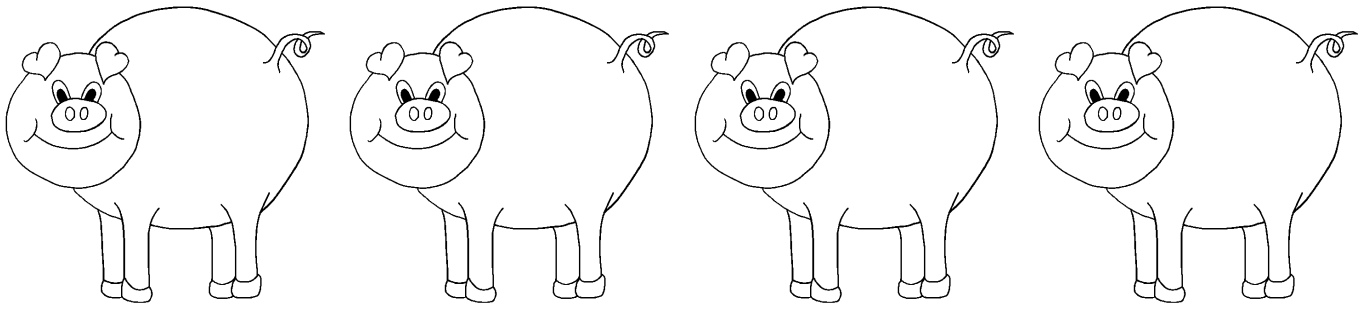

I see 8 pigs.

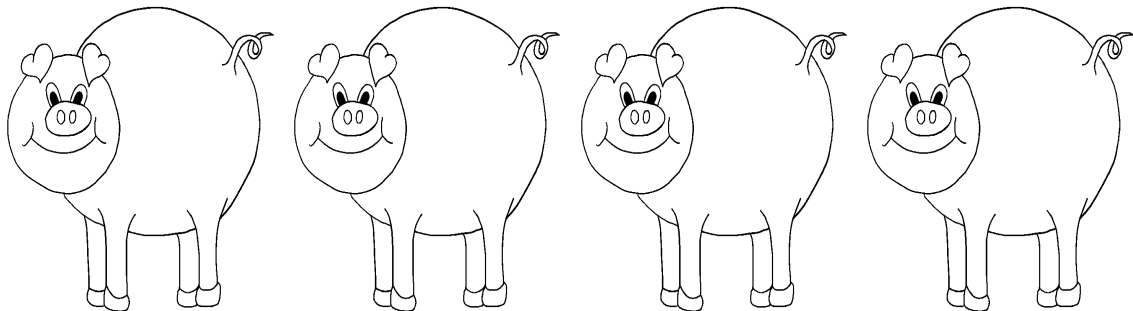
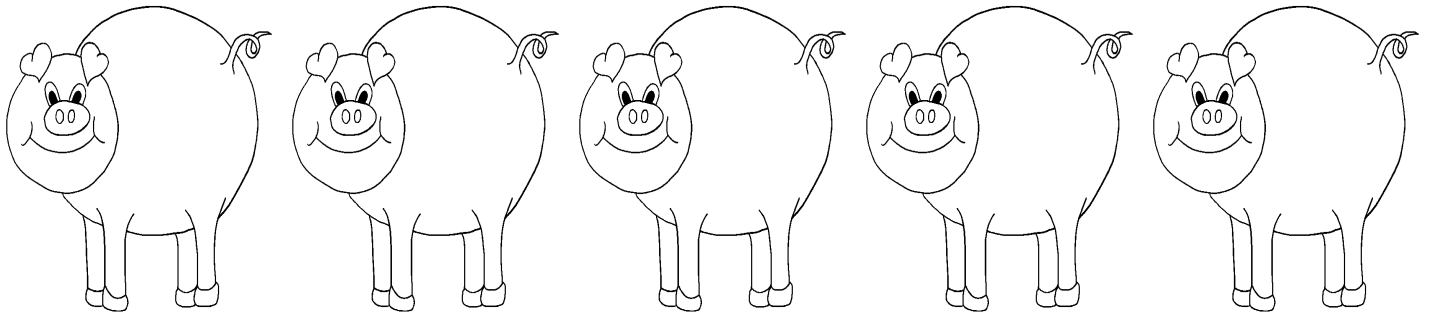

I see 9 pigs.

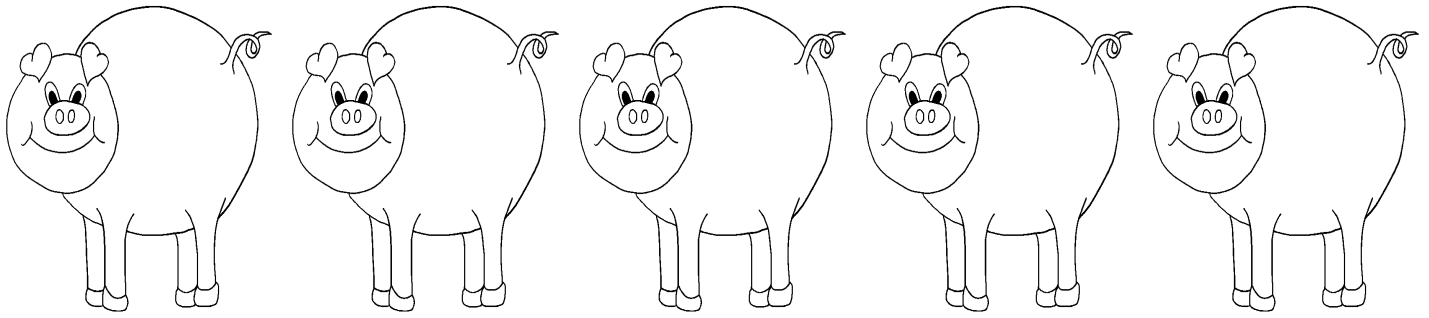
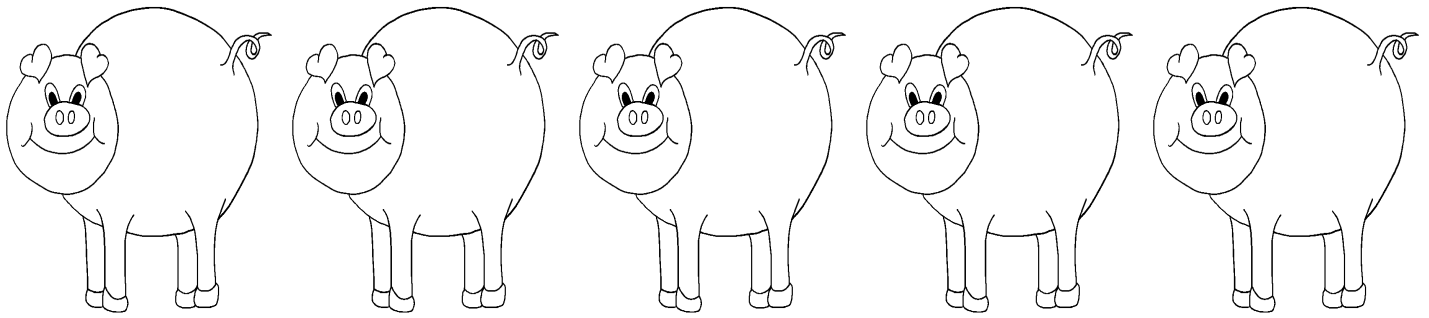

I see 10 pigs.

# I See Pigs

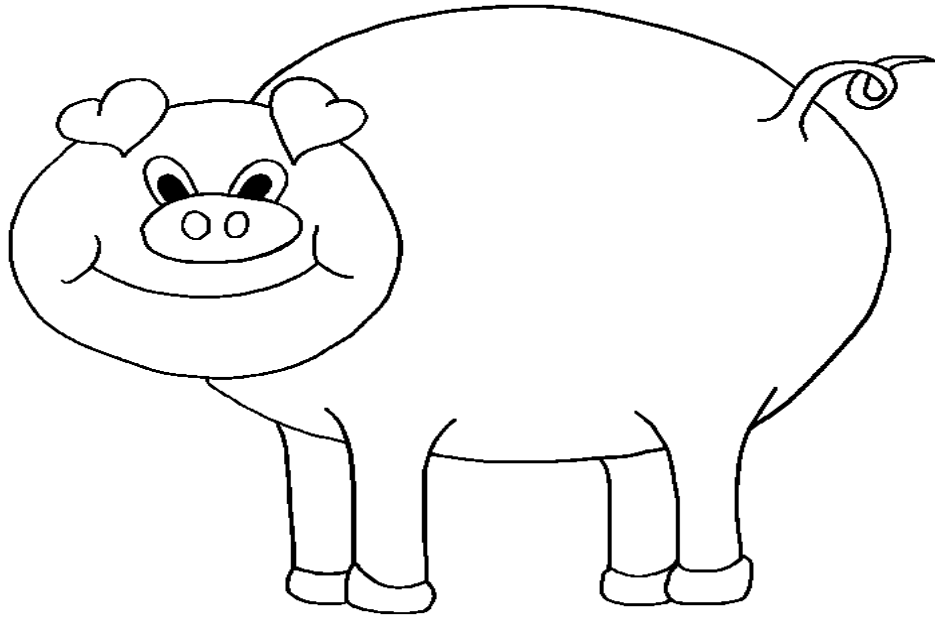

By: \_\_\_\_\_

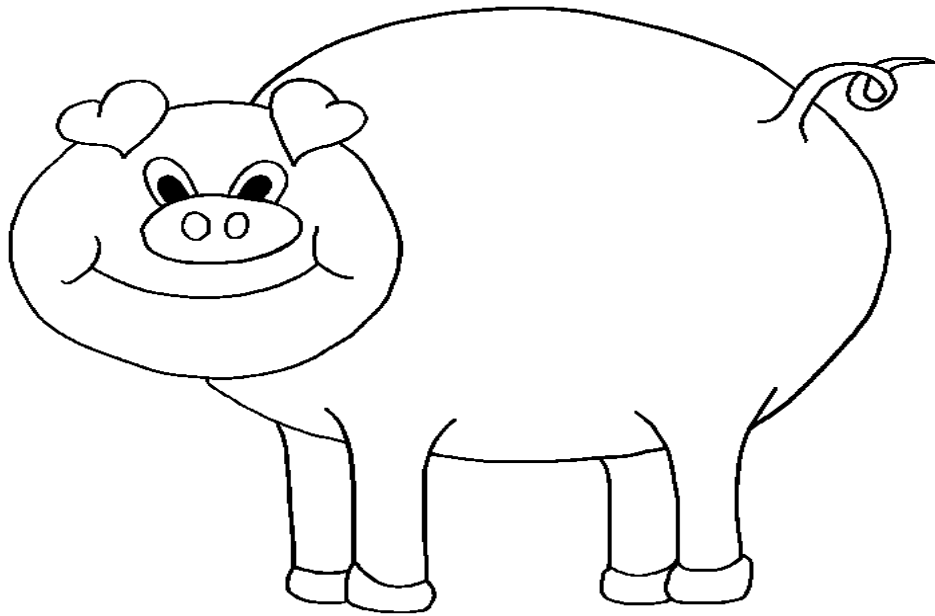

I see \_\_\_\_\_ pig.

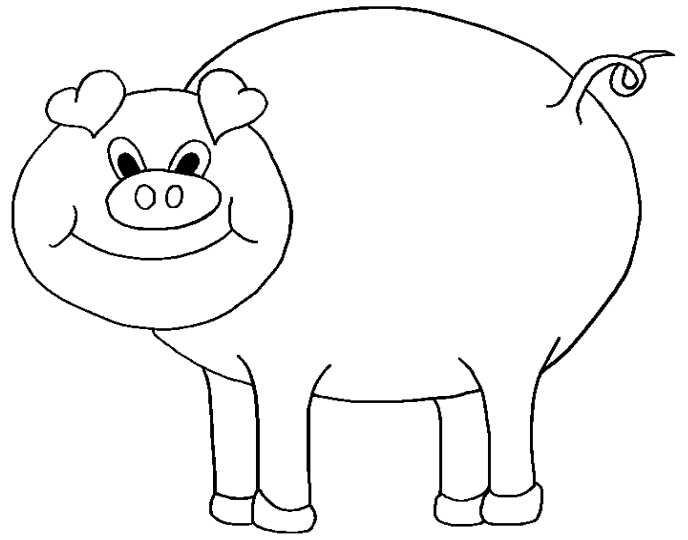
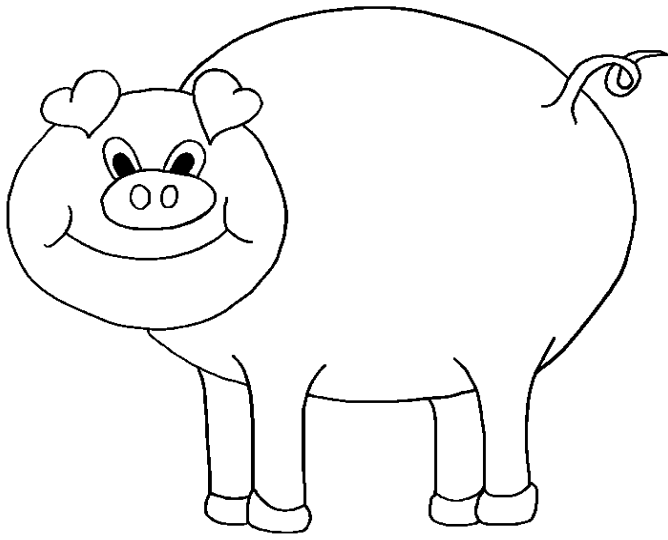

I see \_\_\_\_\_ pigs.

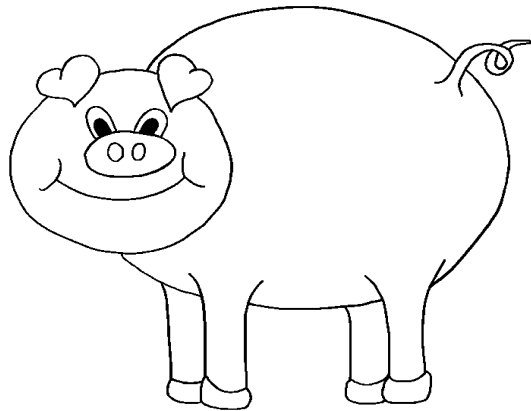
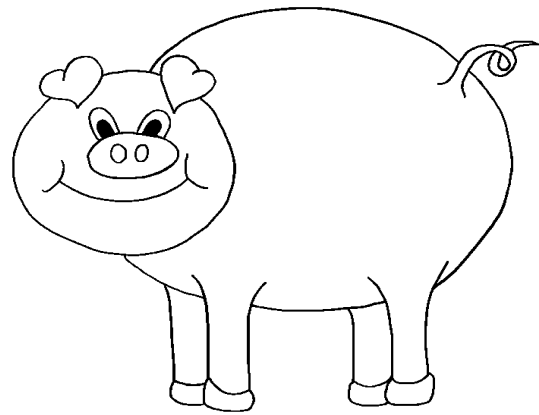
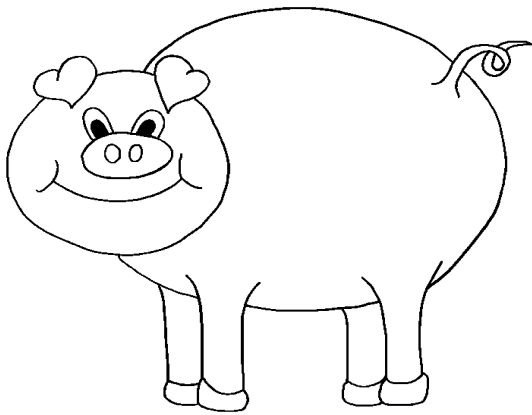

I see \_\_\_\_\_ pigs.

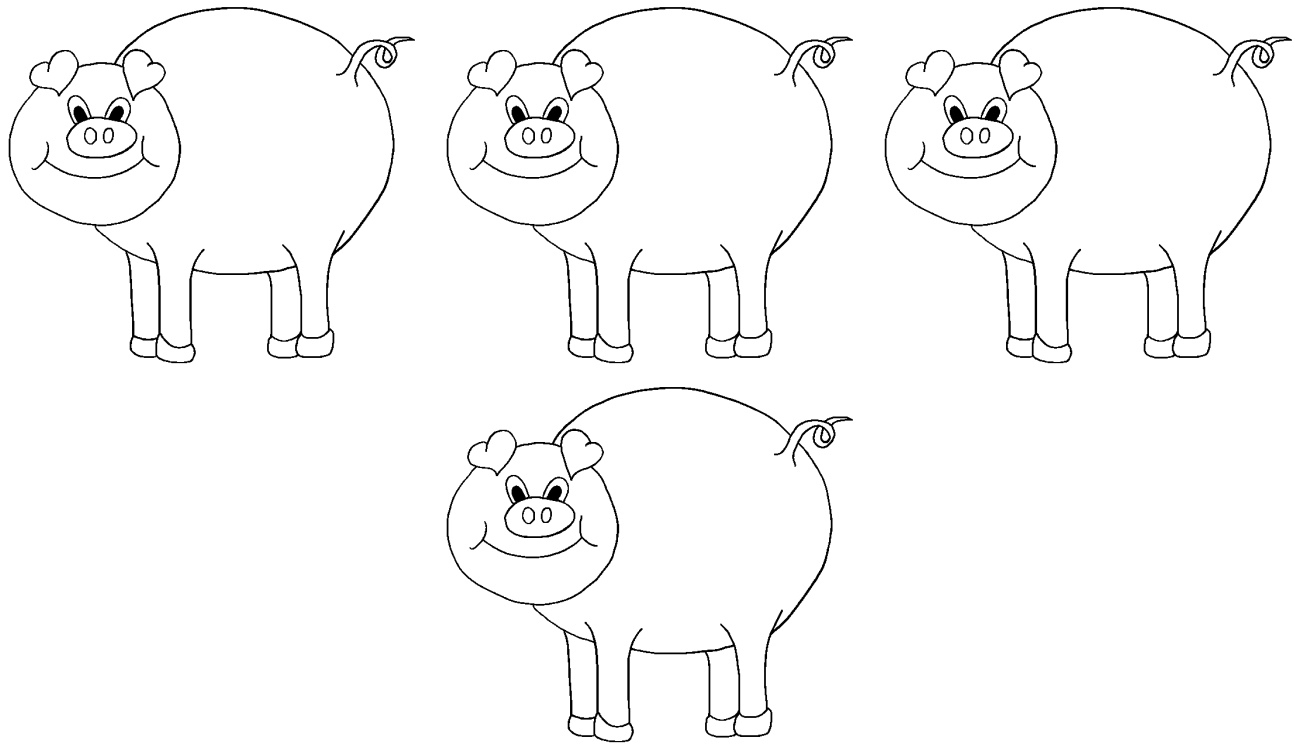

I see \_\_\_\_\_ pigs.

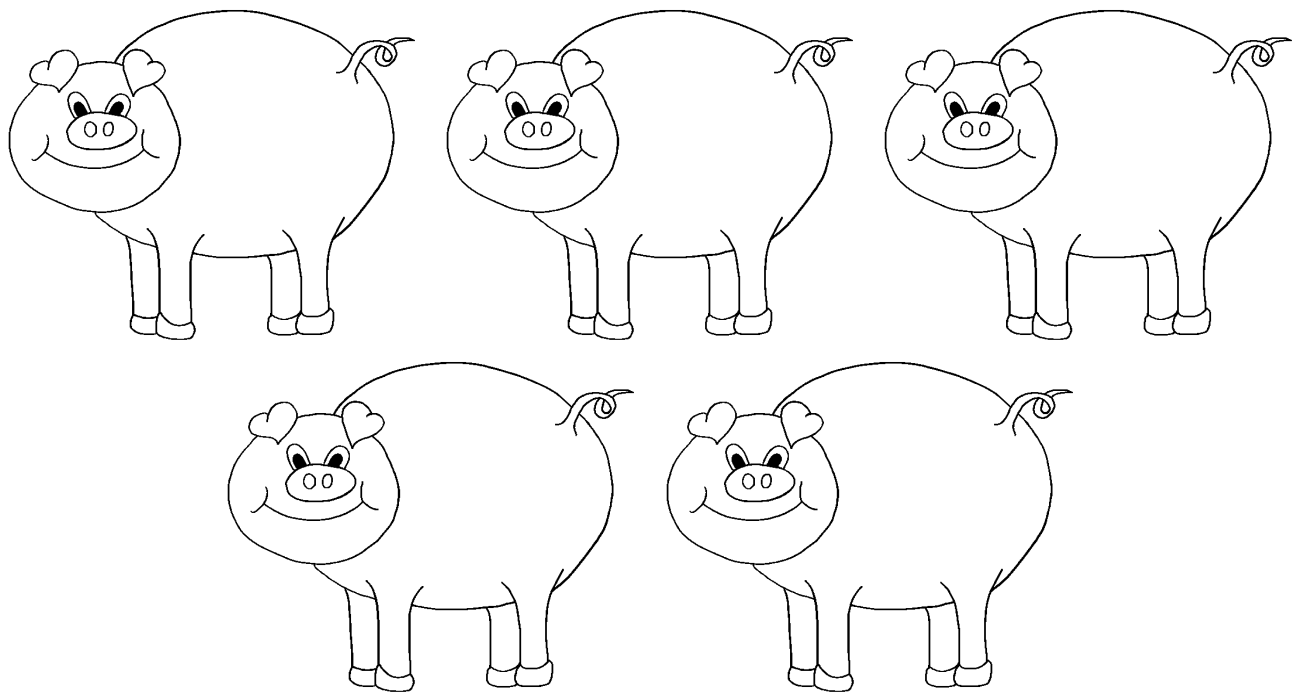

I see \_\_\_\_\_ pigs.

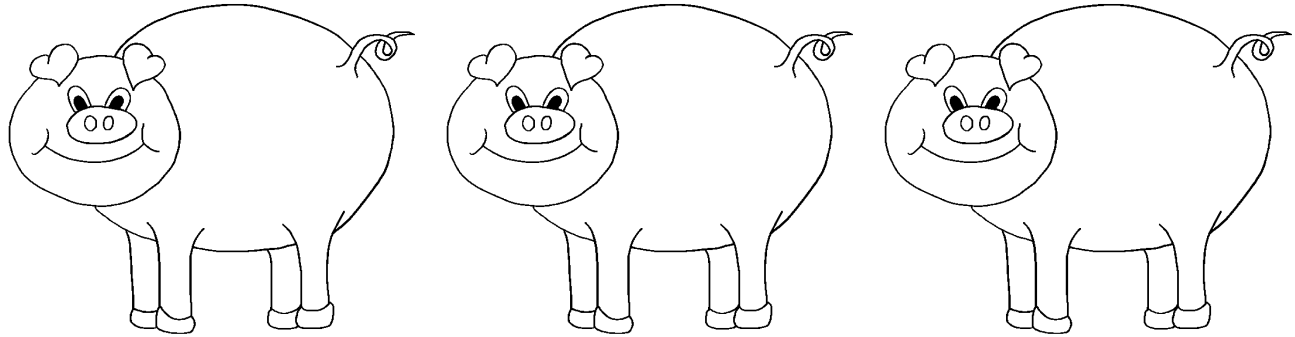
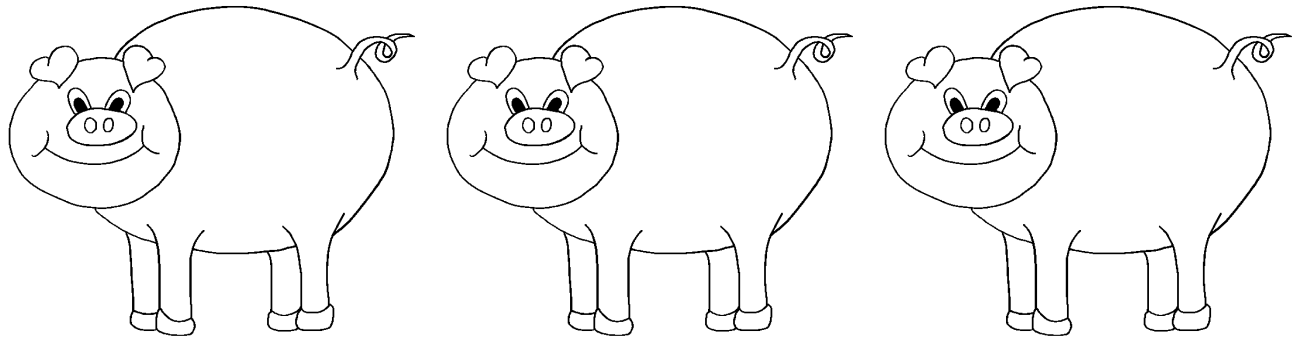

I see \_\_\_\_\_ pigs.

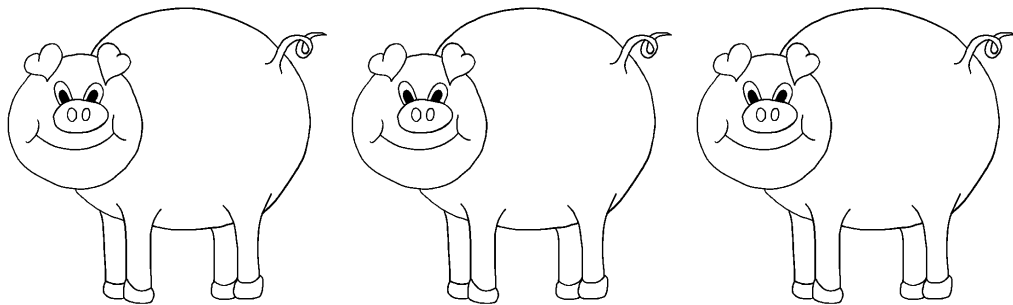
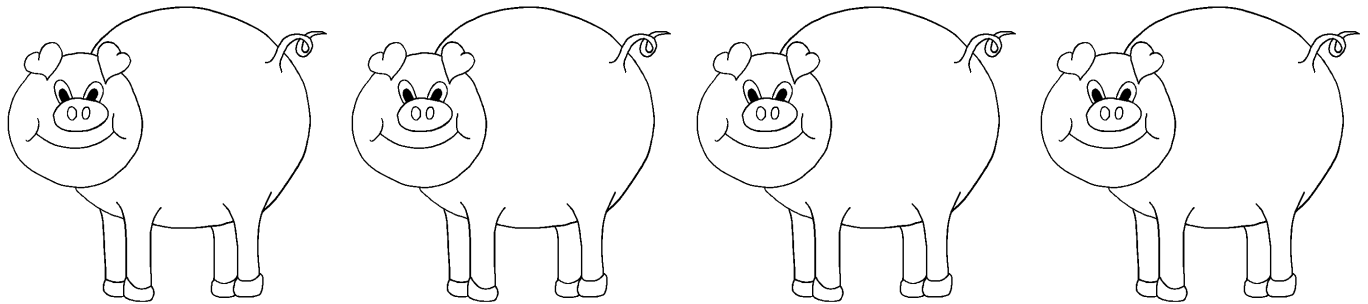

I see \_\_\_\_\_ pigs.

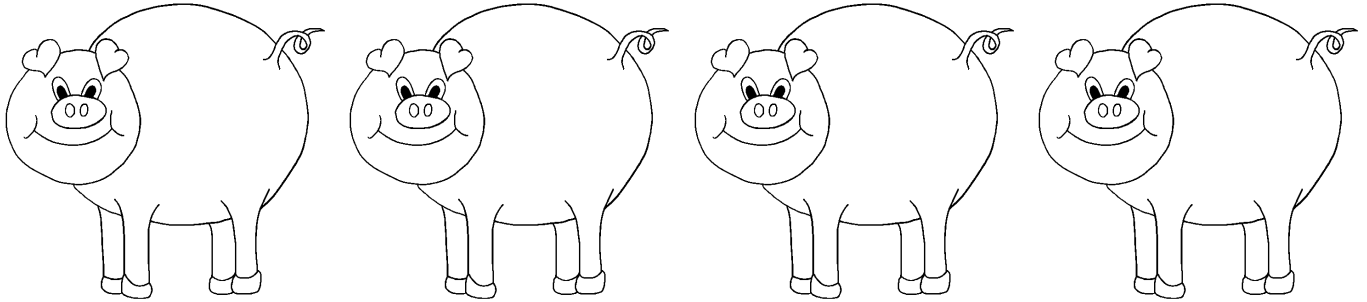
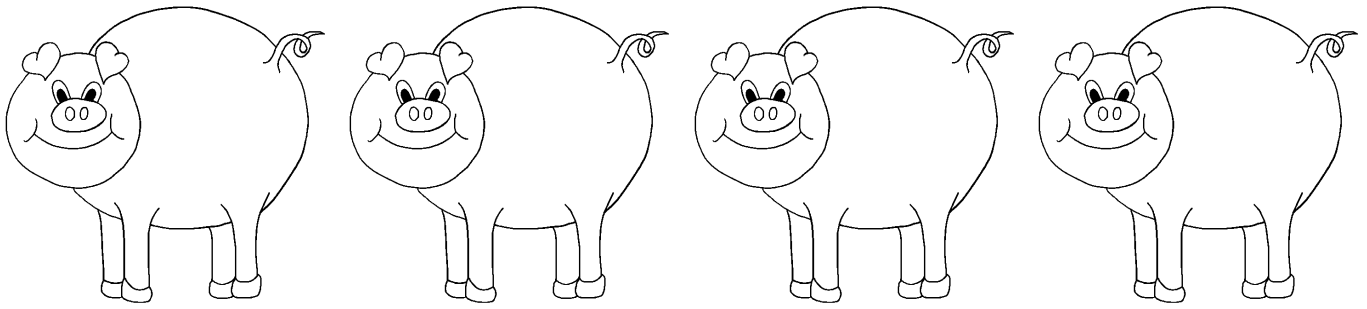

I see \_\_\_\_\_ pigs.

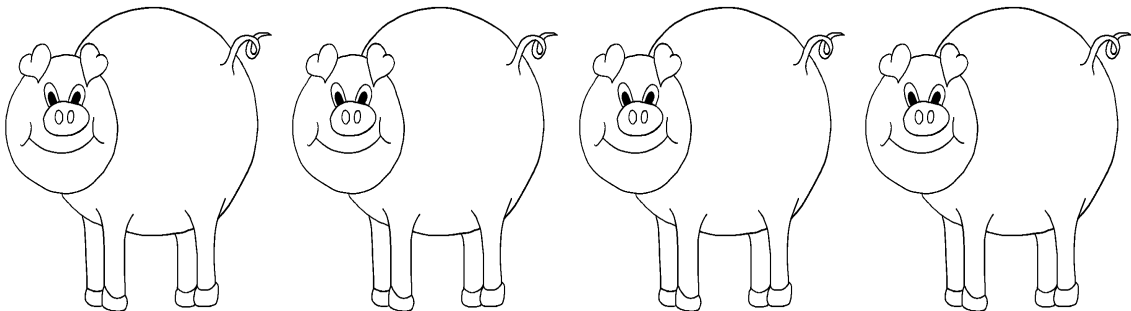
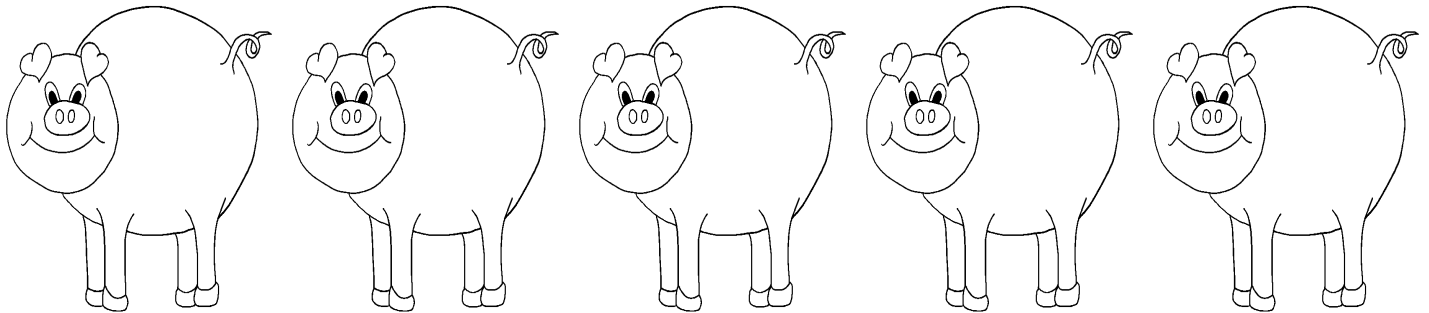

I see \_\_\_\_\_ pigs.

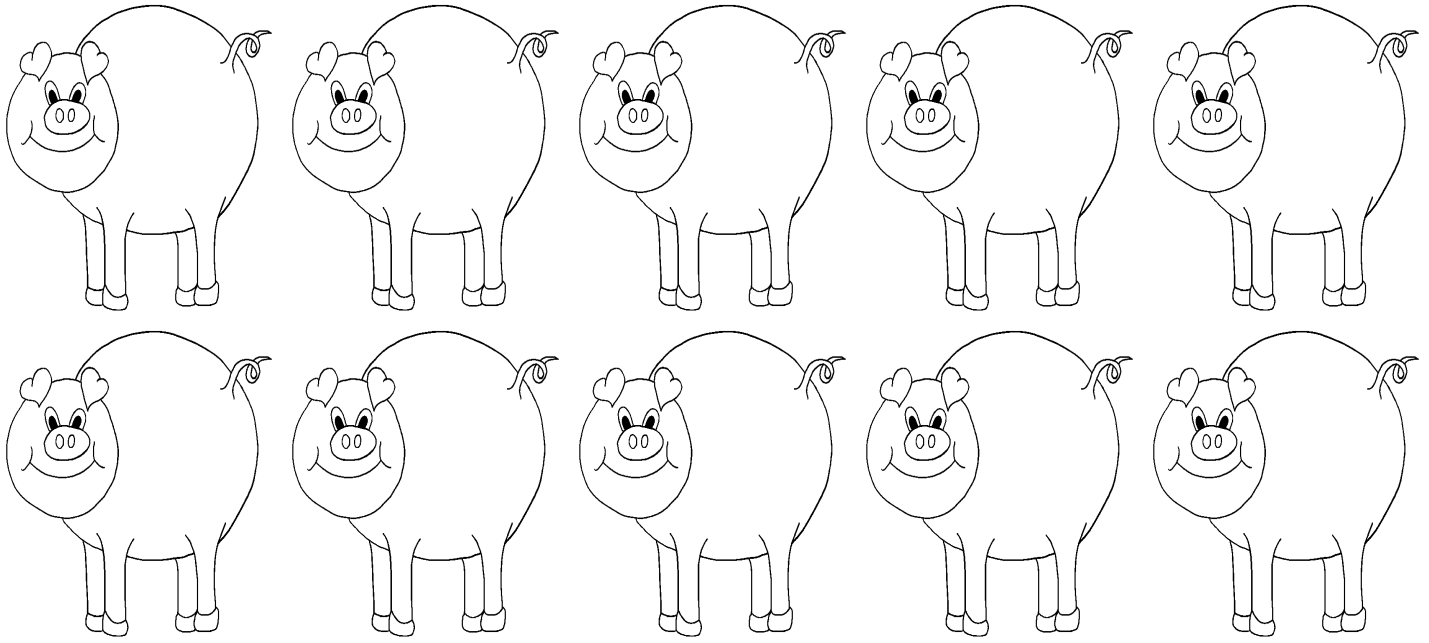

I see \_\_\_\_\_ pigs.

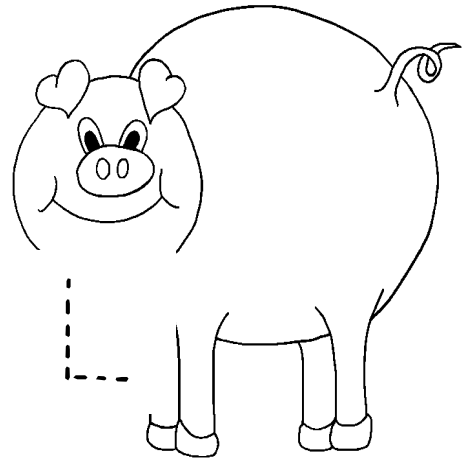
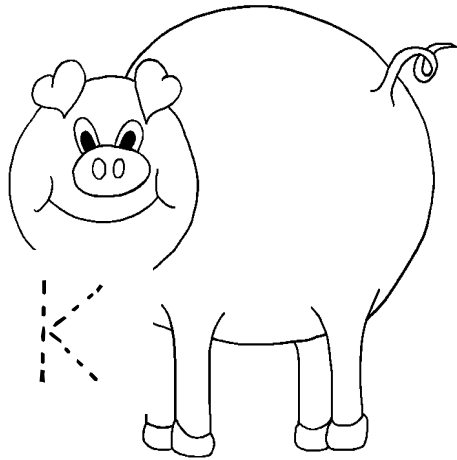
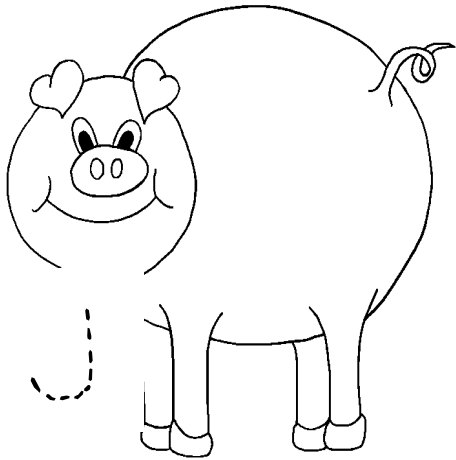
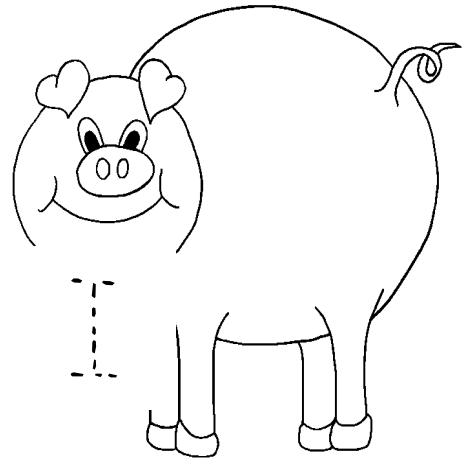
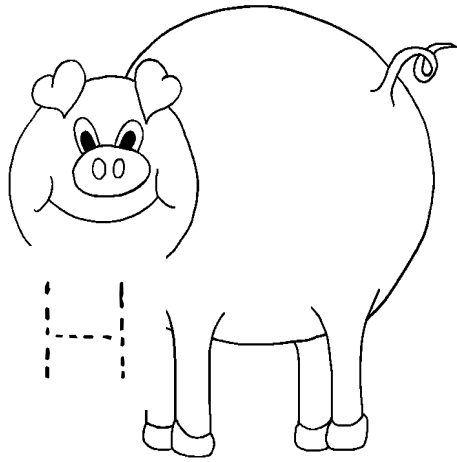
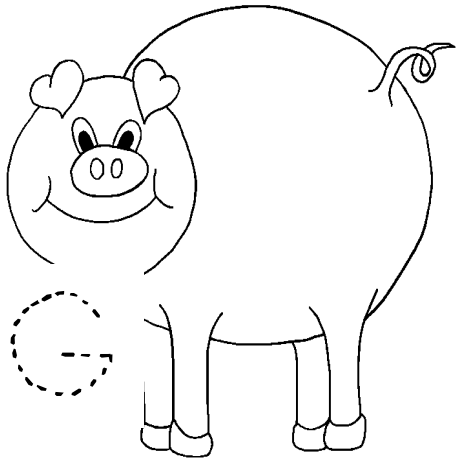
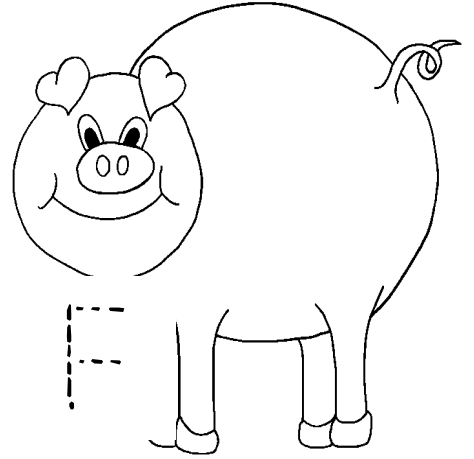
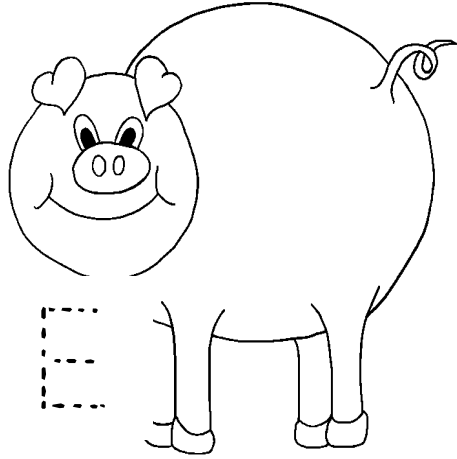
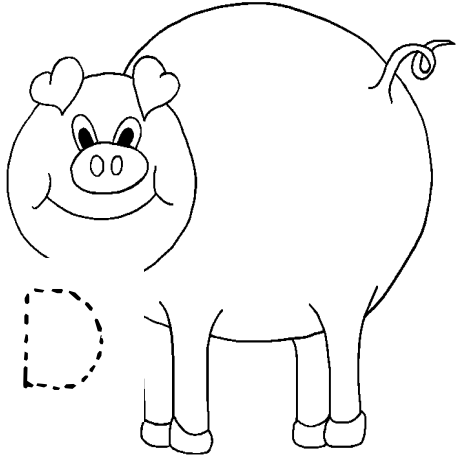
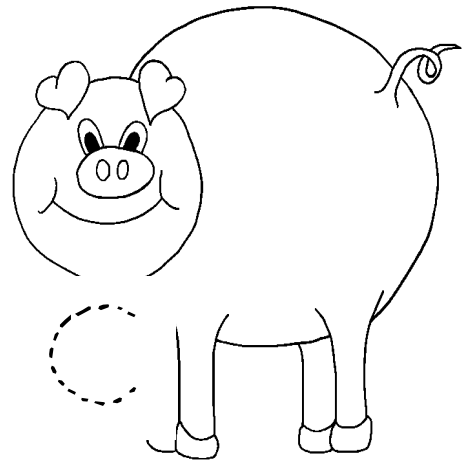
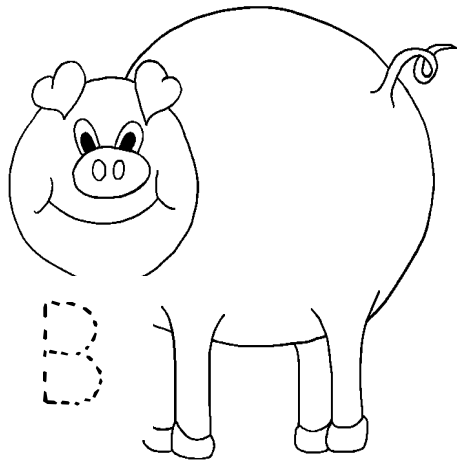
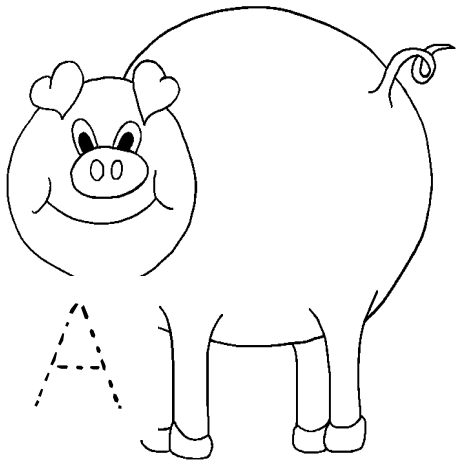

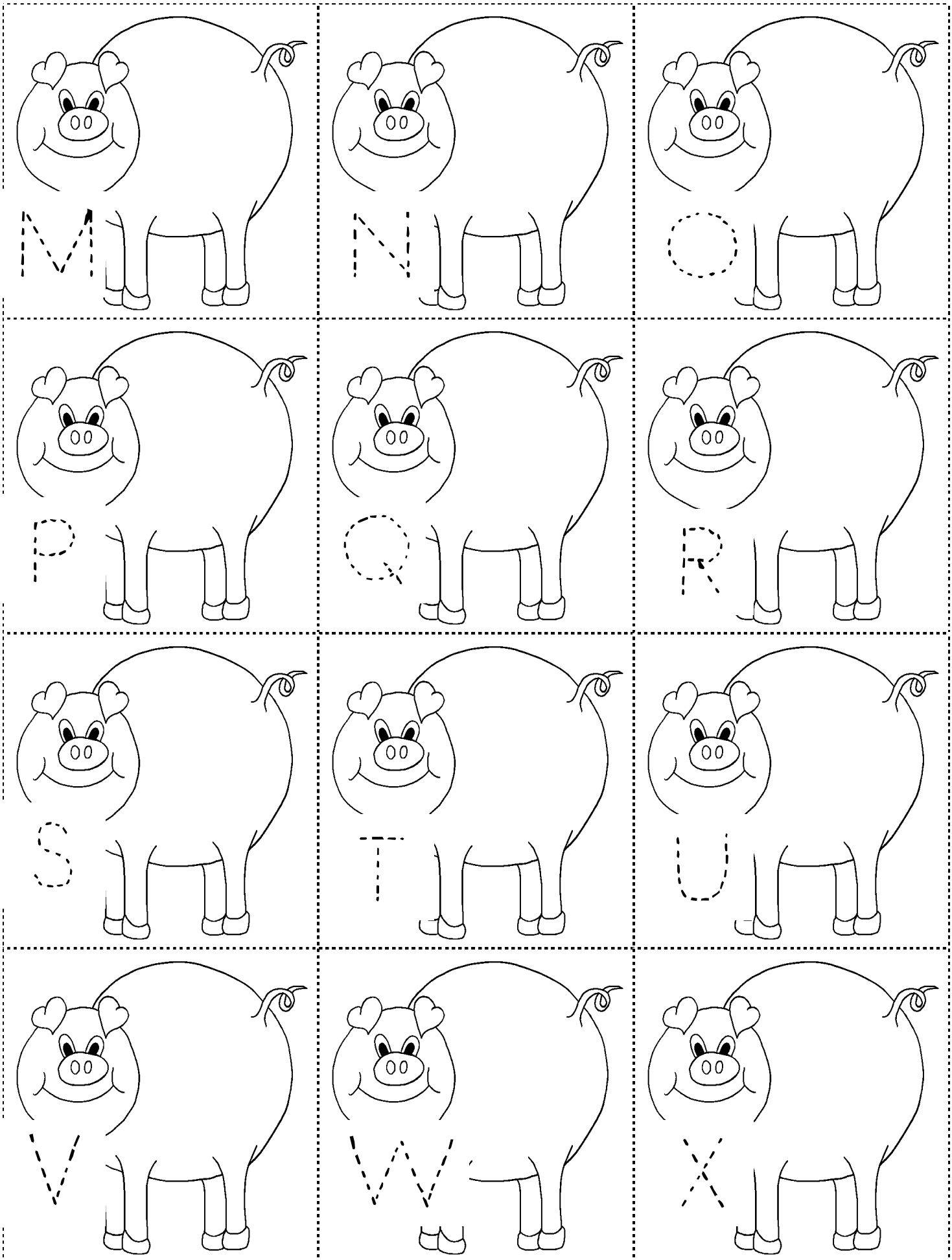

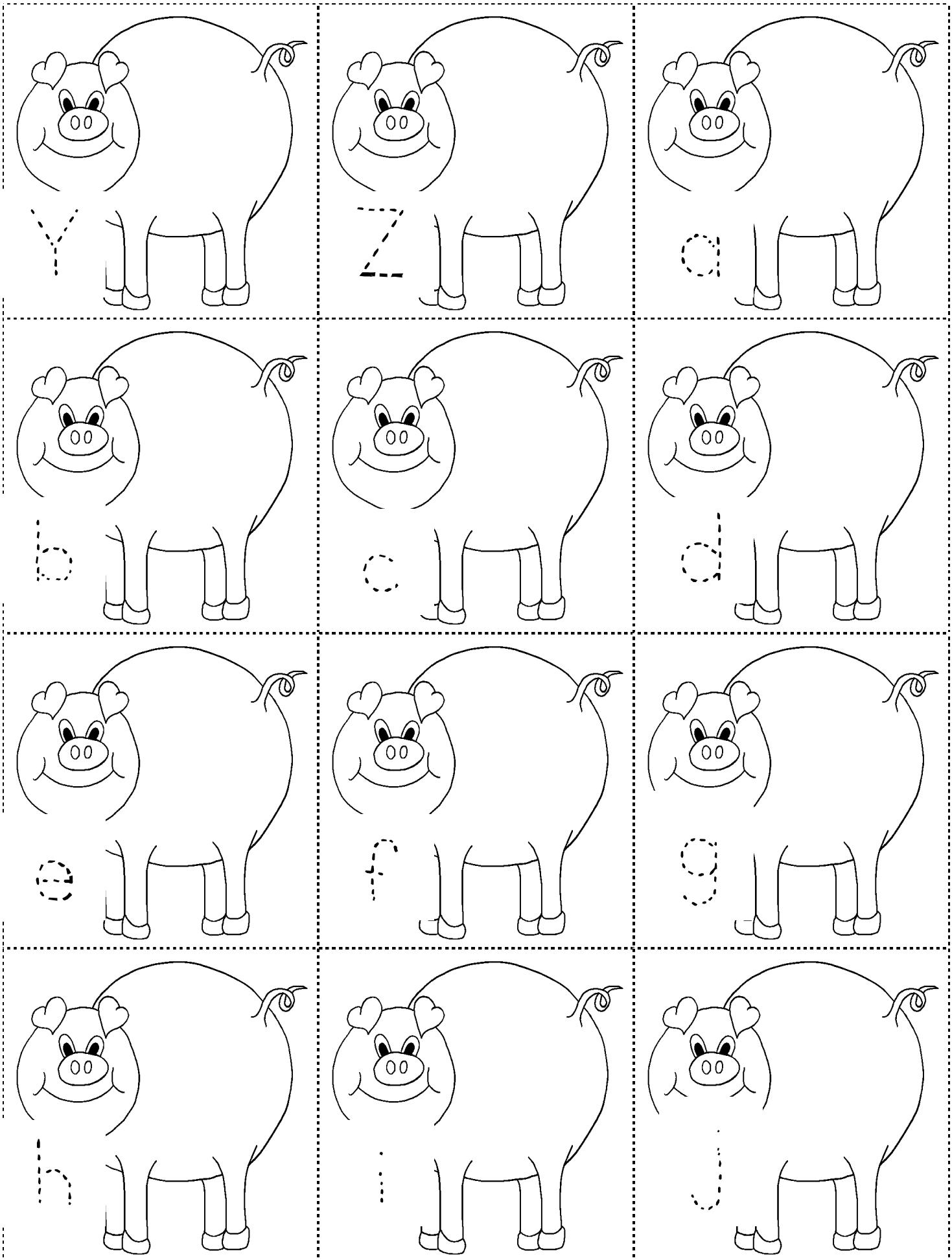

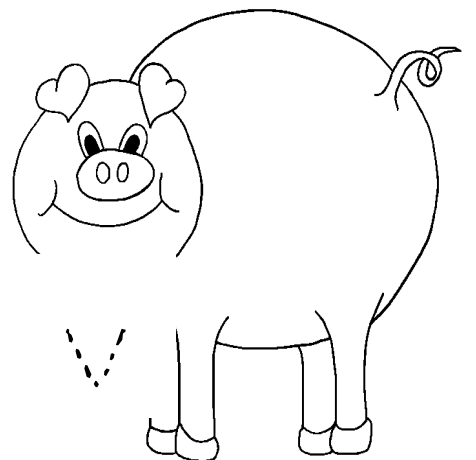
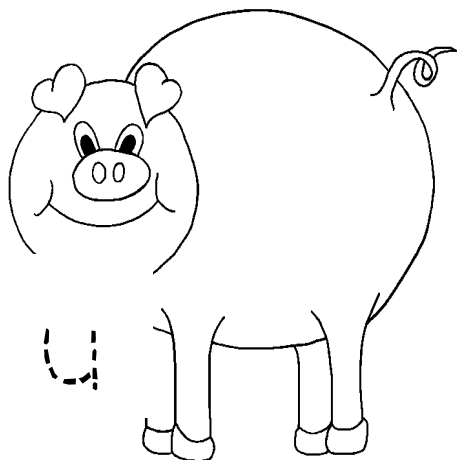
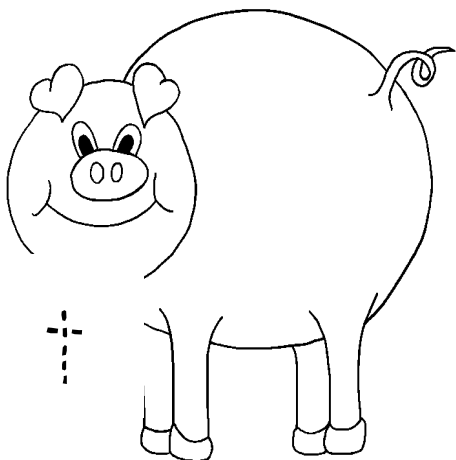
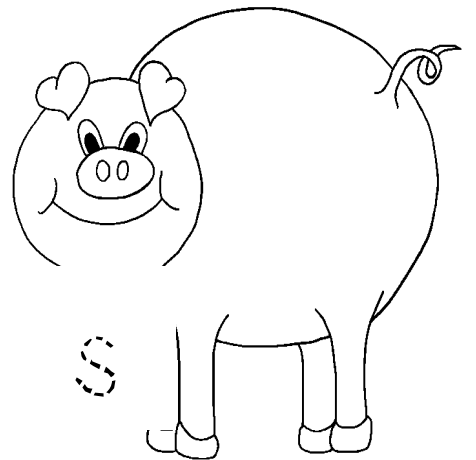
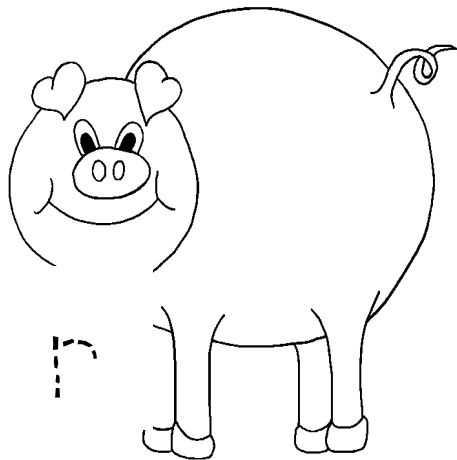
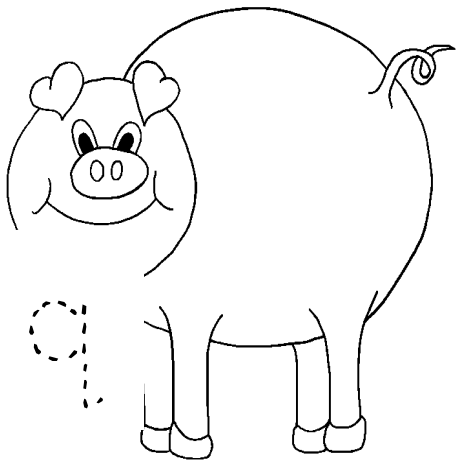
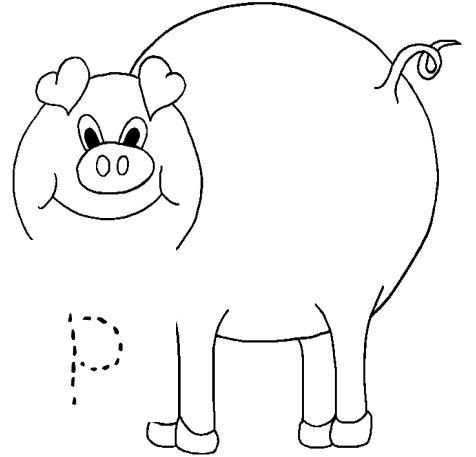
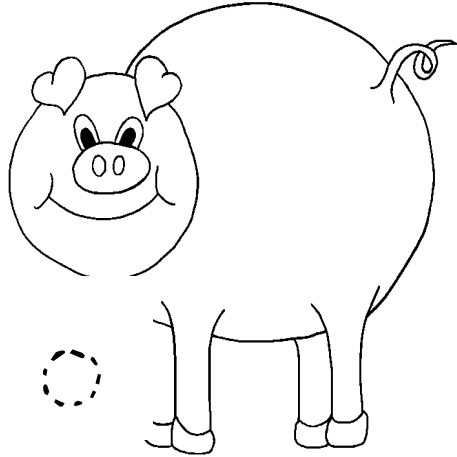
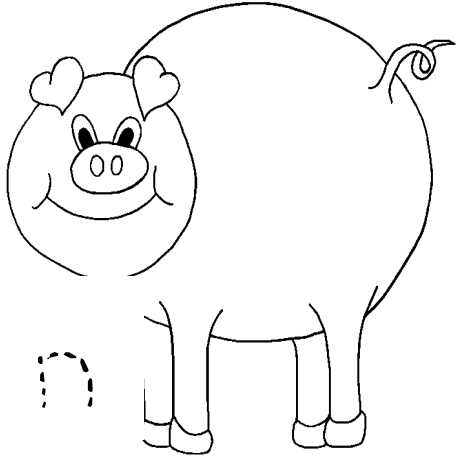
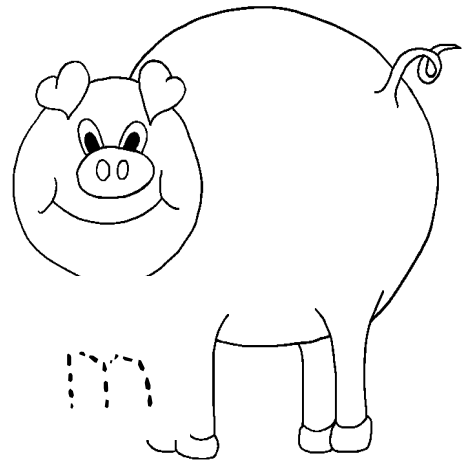
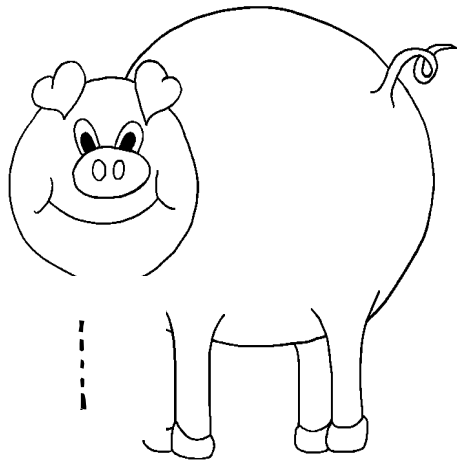
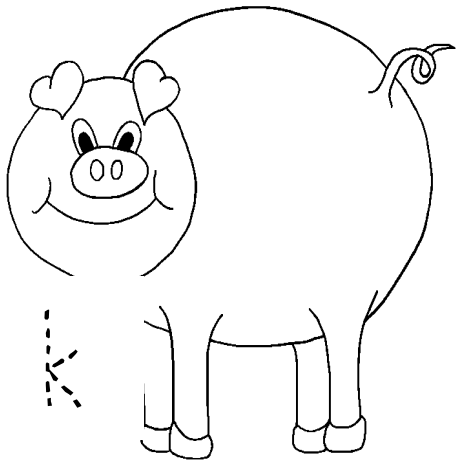

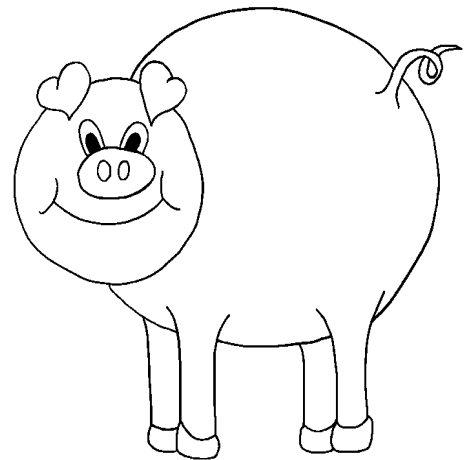
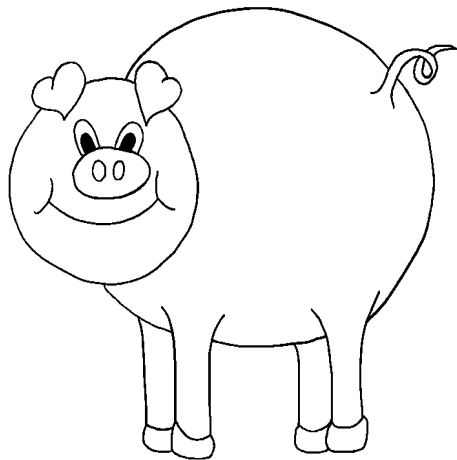
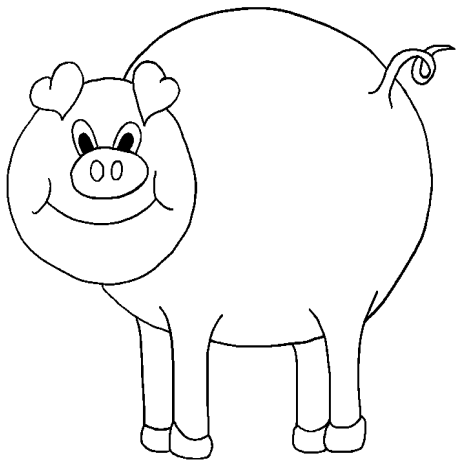
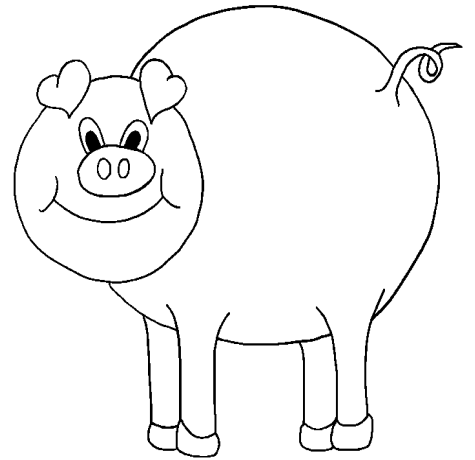
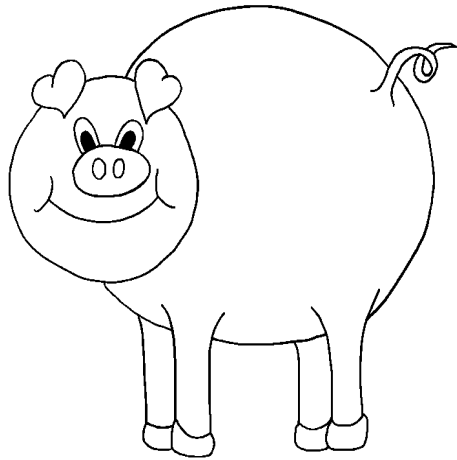
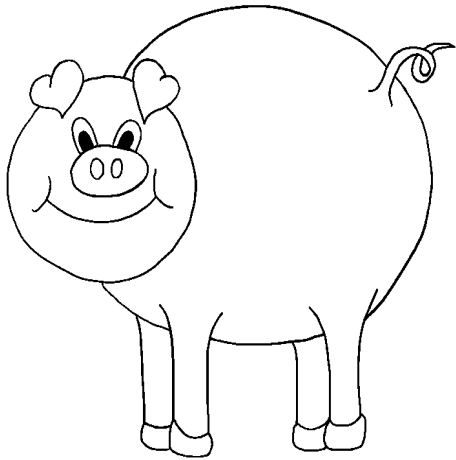
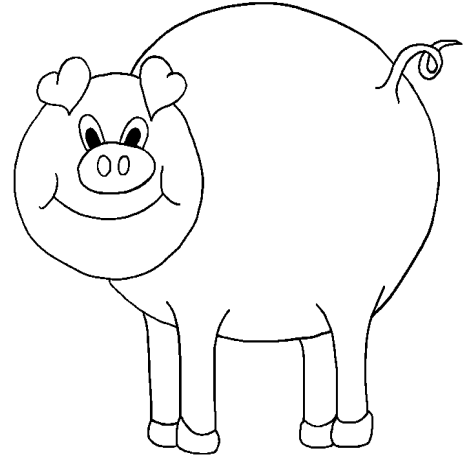
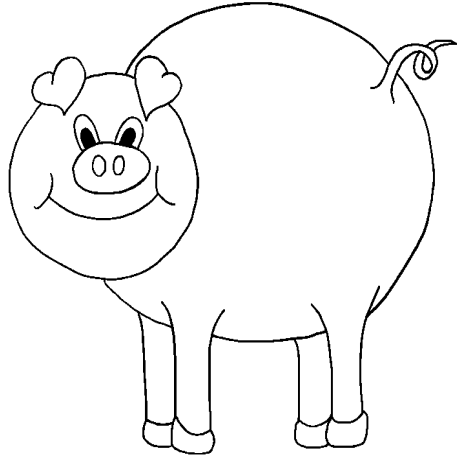
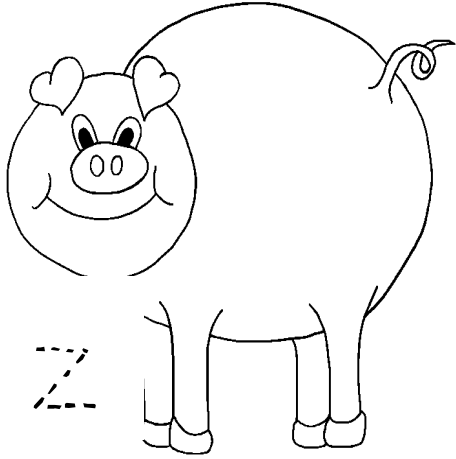
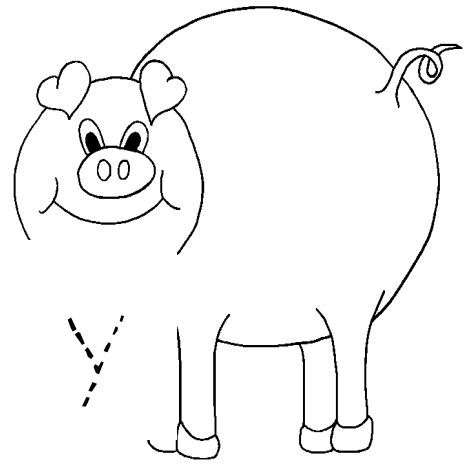
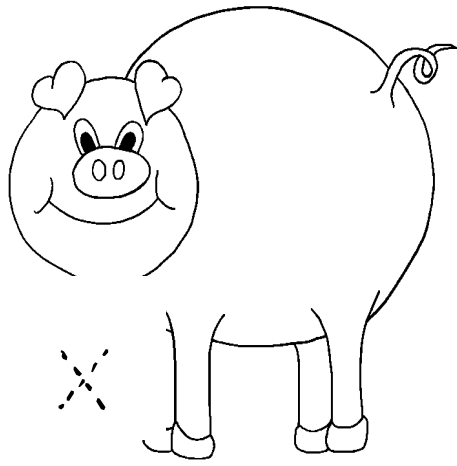
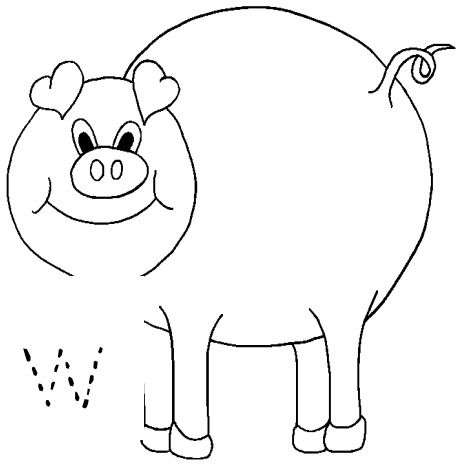

Name: \_\_\_\_\_

What comes next? Finish the patterns.

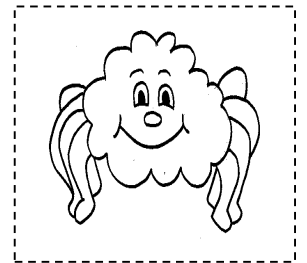
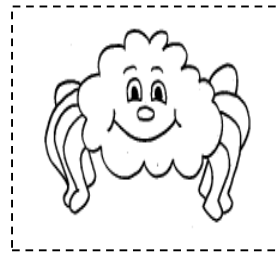
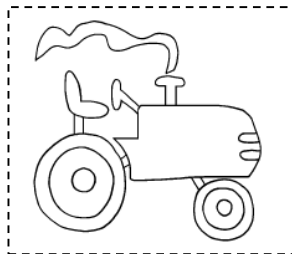
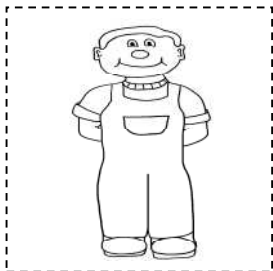
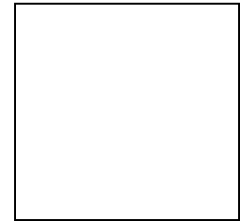
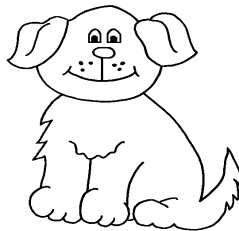
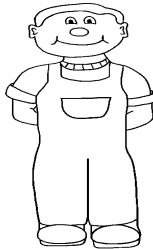
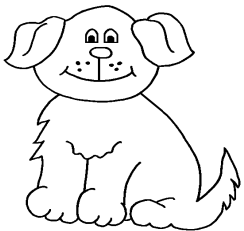
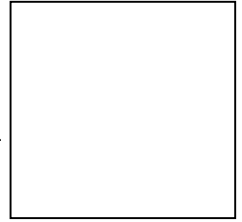
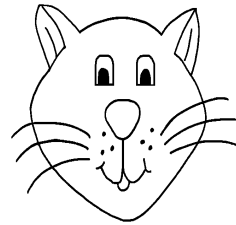
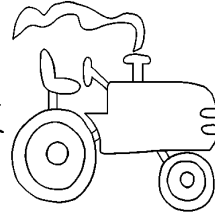
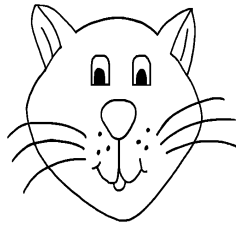
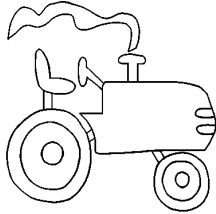
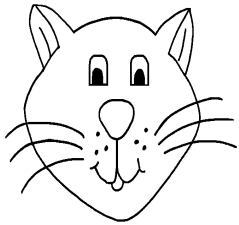
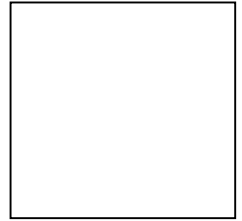
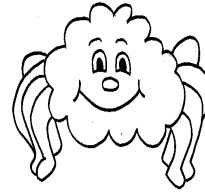
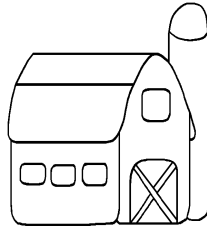
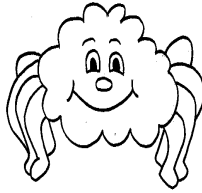
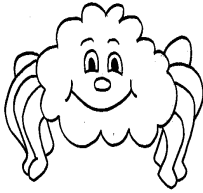
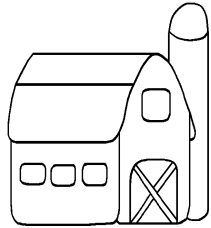
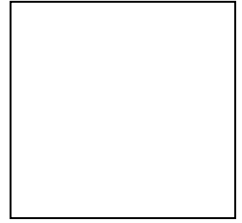
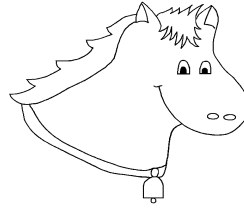
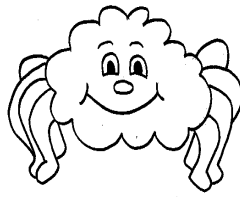
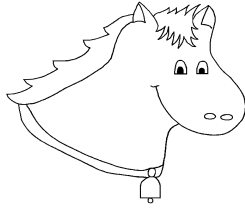
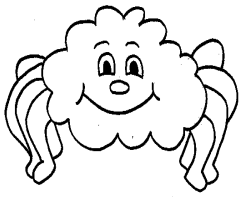

Name: \_\_\_\_\_

### Some Pig!

Write a web for Wilber. What would you write about him if you were Charlotte?

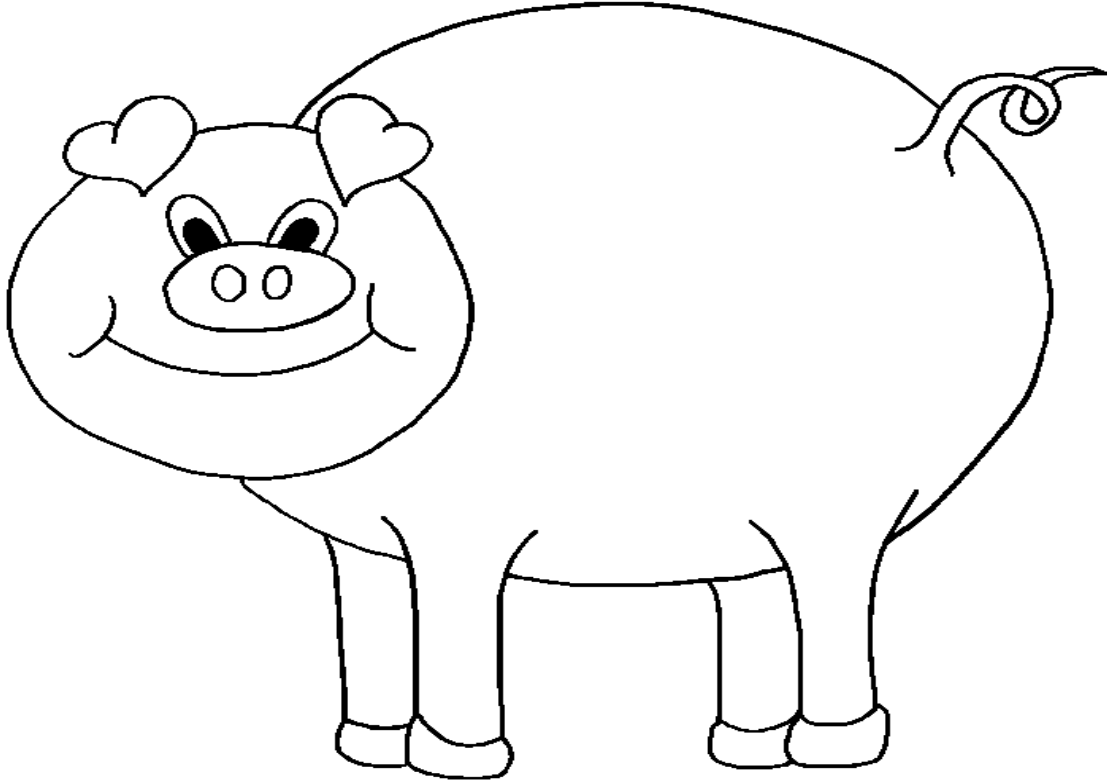

Four sets of handwriting lines, each consisting of a solid top line, a dashed middle line, and a solid bottom line, providing space for writing a web for Wilber.